

**Details of orders related to Centralized Licenses issued from DoT
HQ/CGCA (January'2024 to June'2024)**

Sl. No.	Order/Letter No.	Date of Issue	Information Category	Subject	Page No.
1	L-14042/01/2019-NTG(Part-I)	24.07.2022	SUC	Surrender of MWA and MWB carriers in various service areas.	1-4
2	No.1-34/2013/LFA-II/Part-I	04.11.2022	SUC	Non-payment of LF & SUC by M/s BSNL from 3 rd Quarter of FY 2018-19.	5
3	No.12-75/2022-LFP/139807	28.06.2023	CIRP	SOP regarding realizing Government dues and handling CIRP	6-10
4	No.1-9/2019-LFP-I	04.08.2023	SUC	Adjustment of surplus LF & SUC	11
5	L-14042/01/2019-NTG(Pt-I)	19.09.2023	SUC	Surrender of MWA/MWB carriers in Mumbai, Orissa and Maharashtra LSA-reg.	12-13
6	Email	11.10.2023	SUC	Liberalization of administrative allotted spectrum 4.4 MHz in r/o Voda Idea Ltd.	14-18
7	1020/02/2023-WR	26.10.2023	SUC	Action points with respect to Review Meeting of O/o CGCA by Member(F) on 18.10.2023-reg.	20-21
8	L-14041/02/2023-IMT	16.11.2023	SUC	Assignment of frequencies to BSNL in the 700 MHz,1800MHz band and 2100 MHz band in view of the Cabinet decisions on 23-10-2019,27-17-2022 and 07-06-2023.	22-26
9	50-1/BG Policy/2023B SNL LF SUC Dues	23.11.2023	SUC	Non-payment of LF and SUC for Q1 & Q2-case of M/s BSNL Tamil Nadu Circle for FY 2023-24	27
10	As-13/5/2019-Office of DIR(AS-V)-Part (1)	27.12.2023	TDSAT	Adjustment of Rs. 755.52 crores pursuant to Hon'ble TDSAT order dated 15.12.2023 in MA No. 114/2023 in TP 30 of 2019-reg.	28-29

11	As- 13/5/2019- Office of DIR(AS-V)- Part (1)	02.01.2024	TDSAT	Adjustment of Rs. 755.52 crores pursuant to Hon'ble TDSAT order dated 15.12.2023 in MA No. 114/2023 in TP 30 of 2019-reg	30-31
12	1034/05/2023-WR dated 04.01.2024	04.01.2024	SUC	Payments made by M/s RJI related to SUC for FY 2014-15 to 2018-19 pursuant to Hon'ble SC AGR Judgement dated 24.10.2019 & 25.10.2019.	32-51
13	1020/02/2023-WR	12.01.2024	SUC	Minutes of the Review Meeting on recovery of Outstanding SUC dues held on 09.01.2024.	52-58
14	1- 6/2023/SAR AS /SUC Module	11.01.2024	SUC	Rollout of upgrades in SUC Module in SARAS	59
15	L- 14041/01/2020-NTG	15.01.2024	SUC	Regularization of the spectrum of BSNL post the expiry of service license-reg.	60-61
16	27- 8/LFA/2021/ Misc	16.01.2024	DVR	DVRs of the operators related.	62-63
17	50- 5/DVR/TSPs /2024	17.01.2024	DVR	Regarding timeline for the DVR finalization.	64
18	1- 14/2024/LFA /VIL	25.01.2024	SCN-SUC	SCN for short payment of Quarterly LF dues for Q2 of FY 2023-24 on self-assessment basis in respect of M/s VIL.	65-67

19	1012/02/2023-WR	02.02.2024	TDSAT	Adjustment of Rs. 755.52 crores pursuant to Hon'ble TDSAT order dated 15.12.2023 in MA No. 114/2023 in TP 30 of 2019.	68-70
20	Email	08.02.2024	TDSAT	TDSAT order in TP-30/2019-Instructions for Status Quo to be maintained.	71-80
21	Email	08.02.2024	SUC	BSNL SUC assessment-reg.	81-86
22	L-14010/02/2024-IMT	09.02.2024	SUC	Provisional assignment/extension of the spectrum rights which is expiring in the year 2024, before the conclusion of next spectrum auction (Auction 23-24) to avoid disruption of public services.	87-89
23	1012/02/2023-WR	10.02.2024	SUC	Communicating the Hon'ble TDSAT order dated 07.02.2022 in TP 30 of 2019 – Reg.	90-96
24	L-14010/02/2024-IMT	10.02.2024	SUC	Provisional assignment/extension of the spectrum rights which is expiring in the year 2024, before the conclusion of next spectrum auction (Auction 23-24)	97
25	L-14010/02/2024-IMT	13.02.2024	SUC	Provisional assignment/extension of the spectrum rights which is expiring in the year 2024, before the conclusion of next spectrum auction (Auction 23-24) for VIL	98
26	Email	14.02.2024	SUC	Clarification regarding surrender of MWB by M/s TTML.	99-100
27	Email	15.02.2024	SUC	Circulation of WPC orders relating to surrender of MW carriers-reg	101-106
28	1034/05/2023-WR	26.02.2024	SUC	Clarification on applying Spectrum Usage Charges (SUC) in cases of Spectrum Sharing – Reg.	107-108
29	PCCA/TN/LF-I/2008-	28.02.2024	SUC	Final SUC assessment in respect of M/s Unitech Wireless Ltd. for	109-110

	09/AGR STT-PC/Unitech-TN/10575			the financial year 2008-09 for Tamil Nadu Service area.	
30	Email	13.03.2024	SUC	Revival of BSNL-payment of SUC dues up to the FY 2021-22-Reg.	111-113
31	1034/01/2024-WR	02.04.2024	SUC	SUC claims pertaining to UASL Licenses issued to M/s Unitech Wireless (Tamil Nadu) Private Limited-Reg.	114
32	Email	10.04.2024	SUC	Final Minutes of the Eastern Zone Conference on SUC held on 1 st & 2 nd March,2024 at Bihar Circle, Patna-reg.	115-120
33	L-14041/02/2023-IMT	03.05.2024	SUC	Assignment of frequencies to BSNL in the 700MHz and 2100MHz band-reg	121-124
34	Email	14.05.2024	CIRP	Recovery of SUC dues with respect to companies under liquidation/CIRP proceedings-	125-133
35	Email	15.05.2024	SUC	Allotment of Residual Spectrum in 1800MHz Band left over due to uneven block size in spectrum auction held in Nov 2012-Reg	134-140
36	Email	15.05.2024	SUC	Appeal by M/s BAL on the SUC assessment issued by O/o CCA, Gujarat for FY 2020-21-Reg	141-148
37	Email	15.05.2024	SUC	Case of M/s Etisalat DB Telecom Pvt. In connection with unrealized outstanding dues for Rs. 64,27,247/- for the period during which the licensee was active in Kerala Circle-reg.	149-165
38	Email	20.05.2024	SUC	Extension of provisional assignment of spectrum for UP West LSA - reg	166-168

39	50-1/BG Encashment/ TSPs/2024- Part(1)	20.05.2024	SUC	Adjustment of surplus amount in respect of BAL-reg	169
40	Email	27.05.2024	SUC	Surrender of MW carriers in Tamil Nadu and Bihar LSAs-reg	170- 172
41	12/SUC/Gen eral Corr/Vol.II	27.05.2024	SUC	Non-realization of SUC dues of M/s RCL & M/s SSSL	173- 174
42	Email	27.05.2024	SUC	Re-assignment of MW carries in Assam, Bihar, J&K, UP(E), WB and Orissa-reg	175- 178
43	Email	27.05.2024	SUC	Surrender of MW carriers in Karnataka LSAs-reg	179- 181
44	1012/01/202 4-WR	30.05.2024	SUC	Action taken report on the minutes of the Eastern Zone Conference on SUC held on 1 st & 2 nd March,2024-reg.	182
45	Email	10.06.2024	SUC	Floor SUC Calculation	183- 186
46	L- 14042/02/20 23-IMT-Part (1)	24.06.2024	SUC	Surrender of Microwave Backbone (MWB) carrier in UP (West) and Madhya Pradesh LSA.	187- 190
47	AS- 13/5/2019- Office of DIR(AS-V)- Part(1)	28.06.2024	TDSAT	Adjustment of Rs. 755.52 crores pursuant to Hon'ble TDSAT order dated 10.04.2024 in MA No. 19/2024 in TP No. 30 of 2019.	191- 194
48	AS- 13/5/2019- Office of DIR(AS-V)- Part(1)	28.06.2024	TDSAT	Adjustment of Rs. 755.52 crores pursuant to Hon'ble TDSAT order dated 10.04.2024 in MA No. 19/2024 in TP No. 30 of 2019-reg	195- 196

49	1034/03/2023-WR	28.06.2024	TDSAT	Implementation of Hon'ble TDSAT orders in various court cases filed by M/s Bharti Airtel.	197-205
50	1034/02/2022-WR	02.07.2024	SUC	Implementation of Hon'ble TDSAT orders in various Court cases filed by M/s Vodafone Idea Ltd.- reg.	206-214
51	1000/10/2022-WR	16.07.2024	SUC	Implementation of Court orders & Issue of Demand Notes - reg.	215
52	LFP-10/19/2023-LFP-II	18.07.2024	BG/SUC/LF	Notification of Responsibility Matrix for activities related to financial conditions of License Agreement - Reg.	216-219

Details of orders related to Bank Guarantee of Centralized Licenses issued from DoT HQ/CGCA (January'2024 to June'2024)

Sl. No.	Order/Letter No.	Date of Issue	Information Category	Subject	Page No.
53	50-1/BG policy/2022/ Review of BG	17.01.2024	Extension of BG	Submission of extension of validity period of BGs at least one month prior to their date of expiry as per license agreement.	220
54	50-1/BG Policy/2022/ Review of BG	13.03.2024	Maintenance of BG	Maintenance of Bank Guarantees maintained at Office of Pr. CCAs/CCAs.	221
55	Email	24.06.2024	Adjustment of BG	Regarding adjustment of proceeds of BG encashment of M/s Unitech Wireless(TN) Pvt. Ltd.	222-225
56	1-4/2019-AS-IV	25.06.2024	Release of PBG	Release of PBG in respect of M/s RJIL.	226-228
57	No.50-1/Maintenan	08.07.2024	SOP	SOP for management of BGs	229-243

	ce of BG/2023				
58	50-1/2022- BG Release/TTSL -TTML	08.07.2024	Release of PBG & FBG	Regarding request for release of Performance Bank Guarantee (PBG) and Financial Bank Guarantee (FBG) for ISP License No. 820-438 /2000-LR dated 19.02.2001 furnished by Tata Teleservices (Maharashtra) Limited.	244

**Details of orders related to Decentralized Licenses issued from
DoT HQ/CGCA (January'2024 to June'2024)**

Sl. No.	Order/Letter No.	Date of Issue	Information Category	Subject	Page No.
59	LFP- 10/07/2023- LFP-II	22.01.2024	Special Campaign	Special Campaign regarding Revenue related functions in all Pr. CCA/CCA offices	245-246
60	LFP- 10/14/2023- LFP-II	23.01.2024	PIS	Non enforcement of LF demands which include Revenue from PIS in calculation of UL ISP licensees	247
61	50-1/SARAS NDC MODULE/202 3	23.02.2024	BG of Inactive Licenses	Monitoring of BG of Inactive Licenses	248

62	LFP-10/08/2023-LFP-II	27.02.2024	Bulk SMS Services	Clarification regarding treatment of Revenue from Bulk SMS Services in UL-Audio Conferencing/Audiotex/Voice mail service authorization.	249
63	1-1/2023-LFP	08.03.2024	Violation of Financial Conditions.	Reporting of Violation of Financial Conditions by Pr. CCA/CCA Offices-Reg.	250
64	50-2/SARAS/Revenue-Part (1)	12.03.2024	Other Dues	Reconciliation of Other Dues Data in SARAS	251
65	50-4/Clarification & Guidelines/Pr. CCA Kolkata	21.03.2024	UDIN	Discrepancies noticed in the revenue reported in the documents submitted with CCA offices and revenue reported in the UDIN submitted with ICAI-reg.	252
66	LFP-10/21/2023-LFP-II	29.04.2023	Immersion Program	Action taken on the Major findings during Conduct of Immersion Program on 'UL(VNO)and UL(ISP) comparative challenges 'at Zonal level.	253-258
67	12-55/2022-LFP-I-120938	28.05.2024	FBG & PBG	Clarification/guidelines regarding encashment of FBG & PBG in r/o M/s Apna Tele link Pvt Ltd (ISP-IT) licensee	259-260
68	50-2/Termination/Surrender of License/Cancellation	11.06.2024	Timely reporting of compliance	Timely reporting of compliance made by licensee after issue of show cause notice for violation of license conditions.	261
69	email	13.06.2024	Compliance of financial conditions	Compliance of financial conditions of License agreement by the licensee-Monitoring thereof.	262-264
70	CG-DL-E-24122023-250880	24.12.2023	Gazette Notification	The Telecommunications Act, 2023	265-290

No.: L-14042/01/2019-NTG (Part-I)

Date: 24.07.2022

Government of India
Ministry of Communications
Department of Telecommunications
Wireless Planning & Coordination Wing
6th floor, Sanchar Bhawan,
20, Ashoka Road, New Delhi – 110001

To,
Vodafone Idea Limited
M/s Vodafone Idea Limited,
Konnectus Tower, Bhav Bhuti Marg,
New Delhi-110 002

Subject: Surrender of Microwave Access (MWA) and Microwave Backbone (MWB) carriers in various service areas.

Sir,

I am directed to refer letter no. VIL letter VIL/RCA/SA/Mar/2023/2401 dated 24.03.2023, VIL/RCA/SA/Mar/2023/1401 dated 14.03.2023 and VIL/RCA/GB/Nov/2022/2411 dated 24.11.2022 on the above mentioned subject and to convey that surrender of Microwave carriers (MWA/MWB) have been accepted and taken on record as detailed below:

LSA	Type of Carrier	Carrier Frequency assigned to TSP (in MHz)	Effective date of Surrender
Andhra Pradesh	MWA	14879/15299	30-09-2019
		21294/22526	30-06-2020
		21322/22554	31-03-2019
	MWB	7470/7624	31-03-2019
		7498/7652	31-03-2019
		7554/7708	30-09-2020
Assam	MWB	6152.75/6404.79	30-06-2019
Bihar	MWB	7138.5/7299.5	30-09-2020
Delhi	MWA	14655/15075	31-12-2018
		18140/19150	30-09-2019
		18167.5/19177.5	31-12-2019
		18195/19205	31-12-2018

AVNEESH KUMAR
Digitally signed by
AVNEESH KUMAR
Date: 2023.07.24
13:11:41 +05'30'

		18222.5/19232.5	31-12-2020
		18250/19260	31-12-2018
		14879/15299	31-03-2021
		14907/15327	31-12-2018
		22330/23562	30-06-2021
		21910/23142	31-03-2019
Gujarat	MWA	18525/19535	30-09-2020
		17837.5/18847.5	31-03-2019
	MWB	7442/7596	31-03-2019
		7526/7680	30-06-2019
		7470/7624	31-03-2021
Haryana	MWA	14543/14963	30-09-2019
	MWB	7442/7596	31-03-2019
		7526/7680	31-12-2018
Himachal Pradesh	MWA	18002.5/19012.5	31-03-2021
	MWB	7554/7708	30-06-2019
Jammu & Kashmir	MWA	18002.5/19012.5	31-12-2020
	MWB	6152.75/6404.79	30-06-2019
Karnataka	MWA	14879/15299	31-12-2019
		21994/23226	31-03-2021
		21322/22554	30-06-2020
Kerala	MWB	7498/7652	31-12-2018
		7442/7596	31-03-2019
		7498/7652	30-09-2019
Kolkata	MWA	14795/15215	30-06-2020
		14879/15299	31-12-2020
Madhya Pradesh	MWB	7498/7652	30-09-2019
		7138.5/7299.5	30-06-2020
Maharashtra	MWA	18525/19535	30-06-2019
	MWB	7498/7652	31-12-2018

AVNEESH KUMAR Digitally signed by
AVNEESH KUMAR
Date: 2023.07.24
13:12:15 +05'30'

		7470/7624	31-12-2018
		7498/7652	30-06-2021
		7554/7708	31-12-2020
Mumbai	MWA	18002.5/19012.5	31-12-2020
		14571/14991	31-03-2021
		14599/15019	30-06-2019
		22274/23506	30-09-2021
		22302/23534	31-03-2020
North East	MWB	6152.75/6404.79	30-06-2019
Orissa	MWB	6123.10/6375.14	31-12-2018
		7138.5/7299.5	31-01-2023
Punjab	MWA	21378/22610	31-12-2019
	MWB	7498/7652	31-12-2018
Rajasthan	MWA	14767/15187	30-06-2020
		14795/15215	30-06-2019
	MWB	7498/7652	31-12-2018
		7526/7680	31-12-2018
Tamilnadu	MWA	21322/22554	30-06-2019
		21294/22526	30-09-2020
		18525/19535	30-09-2019
	MWB	6123.10/6375.14	31-12-2018
Uttar Pradesh (East)	MWA	14711/15131	30-06-2019
		14543/14963	30-09-2020
	MWB	7526/7680	30-06-2019
		7498/7652	31-12-2019
Uttar Pradesh (West)	MWA	21238/22470	31-12-2020
	MWB	7442/7596	31-12-2018
West Bengal	MWB	6152.75/6404.79	31-03-2019
		7442/7596	30-06-2019

AVNEESH KUMAR Digitally signed by
AVNEESH KUMAR
Date: 2023.07.24
13:13:07 +05'30'

No.: L-14042/01/2019-NTG (Part-I)

Date: 24.07.2022

2. Dues towards spectrum usage charges, if any, as per prevailing provisions, i.r.o. the above-mentioned MWA/MWB carriers till the effective date of surrender would be payable by you.

3. The surrender of above MW carriers are subject to outcome of Civil Appeal No. 8232 of 2019 pending before Hon'ble Supreme Court.

AVNEESH KUMAR Digitally signed by AVNEESH KUMAR (Avneesh Kumar)
Date: 2023.07.27 13:11:04 +05'30' Assistant Wireless Adviser
to the Government of India

Copy to:

1. DDG (WPF), DoT, Sanchar Bhawan, New Delhi, for necessary action i.r.o. recovery of dues.
2. Director (WMO), Wireless Monitoring Organization (HQ), Pushpa Bhawan, New Delhi – 110 062, for information.



Government of India
Ministry of Communications
Department of Telecommunications
License Finance Assessment Wing

No.1-34/2013/LFA-II/Part-I

Dated: 04.11.2022

To
All Pr. CCAs/ CCAs

Subject: Non-payment of License Fee and Spectrum Usages Charges by M/s BSNL from 3rd Quarter of Financial Year 2018-19.

With respect to the above mentioned subject, letters has been received from CCA offices requesting DOT (Hq) to issue necessary guideline for taking action at CCA level against M/s BSNL for non-payment of LF and SUC from 3rd Quarter of FY 2018-19. In this regards, it is to intimate that with respect to the M/S BSNL cabinet has approved the revival of BSNL and merger of BBNL with BSNL on 27.07.2022 as per DoT HQ OM. No. 20-28/2022-PR dated 02.08.2022, wherein at Para 2.2 it is mention that *"Settlement of AGR dues of BSNL (₹-33,407 Cr as on 31.03.2022) through equity conversion including GST of ₹ 5,344 Cr. The Government will provide budgetary support to BSNL. AGR dues to BSNL would also be settle on the same principle for 5 years from 1st Apr. 2022 onwards...."*

2. In view of the above, I am directed to convey that BSNL payments for their LF and SUC dues up to the FY 2026-27 will be settle as per cabinet decision i.e. through Equity conversion. Thus, CCAs are requested to timely finalize the BSNL DVR (on SARAS), for on time assessment of BSNL at DoT(Hq).

This is for your kind information.

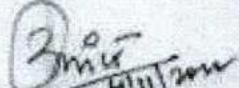
Director (LFA-II)

Copy to:

1. The DDG (WPF), DoT HQ, Sanchar Bhawan, New Delhi-110001.
2. The Asstt. CGCA (Rev.), O/o CGCA, NICF Campus, Ghitorni, New Delhi=110047

Government of India
Ministry of Communication
Department of Telecommunications
Licensing Finance Policy Wing
Sanchar Bhawan, 20 Ashoka Road, New Delhi-110001

No.12-75/2022-LFP/139807

Date: 28.06.2023

Subject: Standard Operating Procedure (SOP) regarding realizing Government dues and handling Corporate Insolvency Resolution Process-reg

The undersigned is directed to forward herewith the Standard Operating Procedure (SOP) regarding realizing Government dues and handling Corporate Insolvency Resolution Process for necessary compliance

This issues with the approval of Secretary(T).

Shauki
28/6/23
ADG(LFP)

Encl: As Above

To:

1. CGCA
2. DGT
3. Wireless Advisor
4. DG(NICF)
5. All Pr. CCAs/CCAs
6. All DDGs of Licensing Wings/DDG(LFA)/DDG(WPF)/DDG(Satellite)

Copy to:

1. PSO to Secretary(T)
2. PSO to Member(F)
3. PSO to Member(T)
4. Sr. PPS to Advisor(F)

**Government of India
Ministry of Communications
Department of Telecommunication
(Licensing Finance Policy Wing)
Sanchar Bhavan, Ashoka Road, New Delhi 110001**

Subject: SOP regarding realizing government dues and handling Corporate Insolvency Resolution Process (CIRP) cases-reg.

It has been observed that there is an inordinate delay in filing claims by certain wings/field offices of DoT leading to these claims not being admitted and extinguished once the resolution plan is passed. To avoid such scenarios in future an SOP is formulated to ensure timebound filing of claims and follow up necessary actions as per the rules/regulations of Insolvency Bankruptcy Code (IBC) 2016.

Standard Operation Procedure (SOP) for Insolvency cases

1. For Licensees whose assessment is done centrally

Step 1: Intimation about CIRP initiation

- LFP wing will monitor all Licensees and will disseminate information about insolvency to the office of CGCA, DG(T) and other wings of DoT. Office of CGCA and DG(T) will communicate with Pr. CCAs/CCAs and LSAs respectively.
- LFP wing will obtain Company Specific Subscription on IBBI website via Corporate Identification Number (**CIN**) of the Company to get regular updates about initiation of insolvency and its status thereafter.

Step 2: Consolidation of Dues and filing of Claims to Insolvency Resolution Professional (IRP)

- Office of CGCA and DG(T) will consolidate dues along with proof of claims pertaining to CCAs, and LSAs respectively and file them in the required format to the Insolvency Resolution Professional (**IRP**)/Official Liquidator (**OL**) within the required time frame without fail. Each office which raises the demand against the licensee is responsible for defending the same before IRP/OL or

any judicial forum as the case may be. A final copy of the filed dues must be shared with LFP wing.

- All other wings of DoT, whoever raises any demand, will consolidate dues along with proof of claims for defending the same and submit to LFP wing in a time bound manner for onwards filing to IRP. No request for onward submission of the claims will be accepted after the cutoff date is passed.

Step 3: Representing DoT in NCLT/NCLAT/Supreme Court

- LFP will be nodal wing to correspond with the Resolution Professional (RP) after filing of dues regarding finalization of the Resolution Plan and defending the interest of the Department before the committee of creditor (COC), Stakeholder Consultation Committee and NCLT, NCLAT and Supreme Court as the case may be.
- While defending the case, LFP wing may assign some responsibilities to any wing/field unit of the Department as the need arises.

In case the Resolution Plan fails:

In the above scenario, the concerned company goes for liquidation and the whole process of submitting claims starts afresh. Dues along with interest may be recalculated upto the Liquidation Commencement Date as mentioned in the Public Announcement.

- If such a case arises, Step 2 and Step 3 will again be repeated in the same manner as defined above.

2. For Licensees whose assessment is done at PrCCA/CCA level

Step 1: Intimation about CIRP initiation

- Office of Pr. CCAs/CCAs will be responsible for monitoring such licensees and disseminate information about insolvency to the office of CGCA, LFP, DG(T) and DS wing who may further disseminate the information to relevant stakeholders.
- PrCCA/CCA will obtain Company Specific Subscription on IBBI website via Corporate Identification Number (CIN) of the

Company to get regular updates about initiation of insolvency and its status thereafter.

Step 2: Consolidation of Dues and filing of Claims to Insolvency Resolution Professional (IRP)

- Concerned Pr. CCA/CCA will take necessary actions with respect to the consolidation of dues and filing of claims.
- Other wing/office will provide consolidated dues, if there are any, to the office of concerned Pr. CCA/CCA before the cutoff dates.
- Each office which raises any type of demand against the licensee must be ready to defend the same before IRP/OL/any judicial forum as the case may be
- No request for onward submission of claims from any wing/field office will be entertained after the cutoff date is passed.

Step 3: Representing DoT in NCLT/NCLAT/Supreme Court

- Concerned Pr. CCA/CCA will represent the Department in Committee of Creditors and NCLT and take all necessary steps for defending the interest of the Department. The concerned Pr CCA/CCA office should keep informed CGCA and LFP wing about all proceedings.
- LFP wing will handle the case in NCLAT and Supreme Court if the need arises.

In case the Resolution Plan fails:

In the above scenario, the concerned company goes for liquidation and the whole process of submitting claims is once again started. Dues along with interest may be recalculated up to the Liquidation Commencement Date as mentioned in the Public Announcement.

- If such a case arises, Step 2 and Step 3 will again be repeated in the same manner as defined above.

3. For Licensees issued by WPC

WPC wing will monitor all the operators/companies whom they issue license or allocate administrative spectrum. Individual licensing group in WPC wing who raises the demand will be responsible for filing and defending the claims before IRP/OL/any judicial forum and share a copy of final dues submitted to IRP/OL with LFP wing. And follow the case in NCLT, NCLAT or Supreme Court whenever required.

In case the Resolution Plan gets rejected:

In the above scenario, the concerned company goes for liquidation and the whole process of submitting claims is once again started. Dues along with interest may be recalculated upto the Liquidation Commencement Date as mentioned in the Public Announcement.

- If such a case arises, the above given process will again be repeated in the same manner as defined above.

4. It is to be noted that during the period of Corporate Insolvency Resolution Process, the concerned office may raise a demand against the licensee against the current dues arising out of use or continuation of the license during the moratorium period.
5. It is also to be stated that all wings of DoT/Field offices who are responsible for raising demands against a licensee, are solely responsible for realization of the same. The responsibility does not end with submission of claims. Each concerned office must be vigilant of CIRP proceedings until the logical resolution of their claims.
6. In case of licenses whose assessment is done by PrCCA/CCAs or WPC, a quarterly report should be submitted to LFP wing regarding the insolvency/liquidation status of all their licensees/operators and the steps taken therein for realization of their claims.
7. Licensing Wings of DoT will provide a certified list of all the companies with the type of license and the CIN of the Company to LFP wing within two weeks of this SOP coming into force.
8. All Legal cases other than the insolvency process will be dealt by those offices who are currently responsible for the same.
9. National Institute of Communication Finance (NICF) shall organize a periodic training program related to process of filing claims and other issues related to Insolvency and Bankruptcy Code, 2016 at regular interval.

This issues with the approval of Secretary(T).

R. Sahibkumar
Director (LFP-I)

**Government of India
Department of Telecommunication
Licensing Finance Policy Wing
Sanchar Bhawan, Ashoka Road, New Delhi 110001**

No:1-9/2019-LFP-I

Date: 04.08.2023

To,
CCA Karnataka
Amenity Block ,Palace Road,
Bengaluru-560001

Sub: Adjustment of Surplus License Fee and Spectrum Usage Charges

Ref:12/LF/GUARD FILE/10663 dated 24.07.2023.

With reference to above referred letter of your office the following is intimated :

1. Intra circle adjustment includes adjustments within two or more SSAs also. Surplus arising within SSAs of same circle will be adjusted as per the SOP .
2. Para 2 of the SOP clearly defines the term Surplus for the purpose of the SOP .

Signed by
Sathish Kumar R
Date: 04-08-2023 19:37:08

**Sathish Kumar R
Director (LFP-II)**

Copy to:
Jt. CGCA(Revenue)

File No. L-14042/01/2019-NTG (Pt-I)
Government of India
Ministry of Communications
Department of Telecommunications
Wireless Planning & Coordination Wing

6th floor, Sanchar Bhawan,
20, Ashoka Road, New Delhi – 110001

Dated: 19-09-2023

To,
M/s Bharti Airtel Limited,
Airtel Centre, Plot No. 16, Udyog Vihar, Phase IV,
Gurugram-122015 (Haryana).

Subject: Surrender of Microwave Access (MWA)/ Microwave Backbone (MWB) carriers in Mumbai, Orissa and Maharashtra LSA-reg

Sir,

I am directed to refer to your letter no. RP/FY 23-24/037/1136 dated 29-08-2023 on the subject and to convey that the surrender of Microwave Access (MWA)/ Microwave Backbone (MWB) carriers has been accepted and taken on record, as detailed below:

Licensed Service Area (LSA)	RF carriers (in MHz)	Bandwidth (in MHz)	Effective date of surrender
Mumbai	14683/ 15103	28	30-09-2023
Orissa	7470/ 7620	28	30-09-2023
Maharashtra	7442/ 7596	28	30-09-2023

2. The effective date of surrender i.e. 30-09-2023 shall be considered for computation of necessary spectrum charges.
3. The other terms and conditions of surrender guidelines no. L-14042/01/2022-IMT dated 10-11-2022 shall be applicable.

Signed by Avneesh Kumar (Avneesh Kumar)
Date: 19-09-2023 11:37:29 Assistant Wireless Adviser
Reason: Approved to the Government of India

Copy to:

1. DDG (WPF), DoT, Sanchar Bhawan, New Delhi, for computation and realization of necessary spectrum charges dues.
2. Director (WMO), Wireless Monitoring Organization (HQ), Pushpa Bhawan, New Delhi – 110 062, for information please.

Email

Pratima Singh

Liberalization of administrative allotted spectrum 4.4 MHz in r/o Voda Idea Ltd

From : Rupa Boddu <rupa.boddu@gov.in>

Wed, Oct 11, 2023 01:04 PM

Subject : Liberalization of administrative allotted spectrum 4.4 MHz in r/o Voda Idea Ltd

BAL & DN

2 attachments

To : G Venkata Bhavani <aolf.ccaap-dot@gov.in>, dbacca-ap@nic.in, CCA Assam <ccaassam@nic.in>, CCA Bihar <cca-bih@nic.in>, CCA CHHATISGARH <cca.cg-dot@nic.in>, CCA DELHI DOT <cca.dl-dot@nic.in>, CCA Gujarat <cca.guj-dot@nic.in>, CCA HARYANA <cca.amb-dot@gov.in>, MAYANK NEGI <cca-telecom-hp@nic.in>, CCA J&K Circle <cca.jk@nic.in>, Dipankar Mahto <cca.jh-dot@nic.in>, Geethanjali H.C <aolf.ccaar-dot@gov.in>, MADHAVI DAS <cca.ka-dot@nic.in>, Ranganath Shyam <ccatrivandrum@nic.in>, pccakolkata@gmail.com, CCA Ccokol <cca@ccakolkata.gov.in>, HARI GOVIND SINGH DHAKAD <cca.mp-dot@nic.in>, cca mhgoa <cca.mhgoa@gmail.com>, CCA MH Goa <cca.mhgoa-dot@gov.in>, ccamumbai@gmail.com, Mali Ramraja <pr.cca@cca.maharashtra.nic.in>, Controller of Communication Accounts NE Circle <cca-necircle@gov.in>, ccane2dimapur@gmail.com, K SAJAL <k.sajal92@gov.in>, CCA ODISHA <ccaodisha.dot@nic.in>, CCA Punjab <cca.pb-dot@nic.in>, CCA Rajasthan <cca-jaip-rj-dot@nic.in>, Dileep Kumar Rathore <dk.rathore84@nic.in>, CCA Tamilnadu <ccatn.tn@nic.in>, ccalfhyd@gmail.com, prcca ts-dot <prcca.ts-dot@gov.in>, Sangeet Kumar <cca.upeast@gov.in>, Nirdosh Kumar Yadav <ccaupwest.me-up@nic.in>, CCA Dehradun <ccaddn-dot@nic.in>, BB Joshi <jtcca.ddn-dot@gov.in>, CCA WB <ccawbc-dot@nic.in>, ccadehradun@rediffmail.com, caolfccaupe@gmail.com, ccaassam@gmail.com, CCA-HR-REV <aorevcca.amb-dot@gov.in>, Chetram Meena <dyccalfdot-mp@nic.in>, revenue ccadelhi <revenue.ccadelhi@gmail.com>

Cc : Ashish Joshi <ashish.joshi@nic.in>, Pratima Singh <dycgcarev-dot@gov.in>, HITHENDRA CHARY <wpf.wr-dot@gov.in>

Respected Sir/Madam

Kindly find the trailing mail received from WR section regarding Liberalization of Admin spectrum of M/s.VIL for kind information and taking necessary action at your end.

With regards

Rupa Boddu AO
(Data Collection- LF &SUC)
Revenue section
O/o CGCA
New Delhi -- 110 047

1007

Government of India
Ministry of Communications
Department of Telecommunications
Wireless Planning & Coordination Wing

6th floor, Sanchar Bhawan,
20, Ashoka Road, New Delhi-110001.

No.: L-14004/03/2018-NTG

Date: 22.03.2019

To,

M/s Vodafone Idea Limited,
7th floor, "Konnectus",
Tower-B, Bhavbhutimarg,
Opposite New Delhi Railway Station,
New Delhi - 110 002

Subject: Liberalisation of administratively assigned 4.4 MHz spectrum in 900 MHz band in West Bengal service area and 4.4 MHz spectrum in 1800 MHz band in each of Assam, Jammu and Kashmir, Madhya Pradesh, North East and Odisha service areas.

Sir,

I am directed to refer to your applications dated 30.08.2018 regarding liberalisation of administratively assigned 4.4 MHz spectrum in 900 MHz band in West Bengal service area and 4.4 MHz spectrum in 1800 MHz band in each of Assam, Jammu and Kashmir, Madhya Pradesh, North East and Odisha service areas and to convey the approval of the competent authority for the liberalisation of 4.4 MHz spectrum held by you in 900 MHz band in West Bengal service area and 4.4 MHz spectrum in 1800 MHz band in each of Assam, Jammu and Kashmir, Madhya Pradesh, North East and Odisha service areas w.e.f. 30.08.2018, subject to payment of Rs. 28.40 Crores (Calculation sheet annexed as Annexure I). Details of the spectrum liberalized are annexed as Annexure II.

2. The use of above liberalised spectrum will be governed by all the relevant conditions laid down in respective NIAs and its amendments and the relevant service licenses and their amendments.

3. Spectrum usage Charges (SUC) will be required to be paid for the above liberalised spectrum in accordance with the SUC Order dated 12th August, 2016, as amended from time to time.

C.B. Singh Raw by MWA
S. S. Singh
22/3/19
9911005961
Vin tk
22.3.19

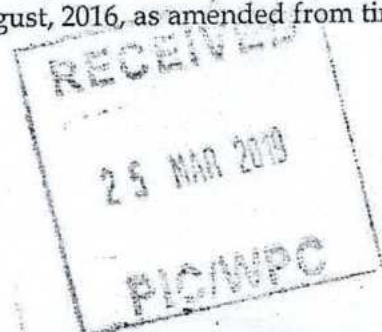

4. Other terms & conditions mentioned in the original earmarking letter/assignment letters/its amendments shall remain unchanged.

Encl: As above.

Vin m
22.3.19
(Vineeth Kurian Mathew)
Assistant Wireless Adviser

Copy to:

- 25/3
- (1) Director (WMO), Pushpa Bhawan, New Delhi - 110 062, for information.
 - (2) DDG (WPF), DoT, Sanchar Bhawan, New Delhi - 1, for information and necessary action.
 - (3) DDG (AS), DoT, Sanchar Bhawan, New Delhi - 1, for information and necessary action, if any.

Annexure I at the time of liberalization for the period from 30.08.2018 to the end date of license as per guidelines of liberalization

Annexure I

Name of the service area	Date of liberalization	Last date of validity of license	Date of approval by NCI, T (Mumbai)	Number of days from the date of liberalization and last date of validity of license	Total quantity of spectrum held	Quantity of spectrum in 900 MHz band	Quantity of spectrum in 1800 MHz band	Quantity of spectrum in 900 MHz band	Quantity of spectrum in 1800 MHz band	Rate of spectrum per MHz /year in 900 MHz band	Rate of spectrum per MHz /year in 1800 MHz band	Market price of spectrum in 900 MHz band	Market price of spectrum in 1800 MHz band	Total market price	Entry fees for 20 year	Entry fees pro rated for the said period	Net amount payable as per M&A guidelines dated 20.02.2014 (in Crores)	already paid at the time of merger	net payable
Assam	30-08-18	4-Dec-2026	19-Jan-18	3019	4.4	0	4.4	0	4.4	0	2.59	0	94.26	94.26	5	2.07	92.19	89.28	2.91
J&K	30-08-18	4-Dec-2026	19-Jan-18	3019	4.4	0	4.4	0	4.4	0	0.85	0	30.93	30.93	2	0.83	30.11	29.02	1.09
MP	30-08-18	29-Mar-2027	19-Jan-18	3134	4.4	0	4.4	0	4.4	0	5.37	0	202.88	202.88	17.45	7.49	195.39	188.59	6.80
NE	30-08-18	4-Dec-2026	19-Jan-18	3019	4.4	0	4.4	0	4.4	0	0.72	0	26.20	26.20	2	0.83	25.38	24.28	1.09
Odisha	30-08-18	4-Dec-2026	19.01.2018	3019	4.4	0	4.4	0	4.4	0	2.63	0	95.71	95.71	5	2.07	93.65	90.37	3.28
West Bengal	30-08-18	22-Mar-2024	19-Jan-18	2032	6.2	0	1.8	0	4.4	0	16.45	0	402.948	402.95	liberalized	13.27	402.95	389.72	13.23
														852.94	TOTAL	13.27	839.66	811.26	28.40

Net Payable
22.5.14

Details i.r.o. spectrum liberalized for Vodafone Idea Ltd.

LSA	Frequencies liberalized (in MHz)	Quantum of Spectrum liberalized (in MHz)	Date of Expiry	Reference
900 MHz band				
West Bengal	In Siliguri: 893.7 - 896.3 / 938.7 - 941.3 913.3 - 914.1 / 958.3 - 959.1 Along the Howrah-Pradhankanta railway track: 894.1 - 898.1 / 939.1 - 943.1 In rest of the service area except Siliguri and Howrah-Pradhankanta railway track: 894.5 - 898.1 / 939.5 - 943.1 913.3 - 914.1 / 958.3 - 959.1	4.4	22.03.2024	L-14047/02/2004-NTG dated 12.08.2004 (Original), L-14004/02/2018-NTG dated 14.09.2018 (Revised).
1800 MHz band				
Assam	1747.5 - 1751.9 / 1842.5 - 1846.9	4.4	04.12.2026	L-14042/43/2004-NTG dated 11.01.2008 (Original), L-14009/01/2014-NTG (Pr.II) dated 23.10.2018(Revised).
Jammu and Kashmir	1749.1 - 1753.5 / 1844.1 - 1848.5	4.4	04.12.2026	L-14043/09/2006-NTG dated 11.01.2008 (Original), L-14004/16/2016-NTG dated 10.11.2016 (Revised).
Madhya Pradesh	1760.5 - 1764.9 / 1855.5 - 1859.9	4.4	18.12.2027	L-14043/04/2006-NTG dated 11.02.2008 (Original), L-14004/09/2016-NTG dated 25.04.2016 (Revised).
North East	1754.9 - 1759.3 / 1849.9 - 1854.3	4.4	04.12.2026	L-14047/07/2006-NTG dated 11.01.2008 (Original), L-14004/16/2016-NTG dated 10.11.2016 (Revised).
Odisha	1747.9 - 1748.5 / 1842.9 - 1843.5, 1752.9 - 1754.7 / 1847.9 - 1849.7, 1758.5 - 1760.5 / 1853.5 - 1855.5	4.4	04.12.2026	L-14047/02/2004-NTG dated 11.01.2008 (Original), L-14004/09/2016-NTG dated 09.06.2016 (Revised).

Government of India
Ministry of Communications
Department of Telecommunications
Wireless Planning & Coordination Wing

6th floor, Sanchar Bhawan,
20, Ashoka Road, New Delhi-110001.

No.: L-14004/03/2018-NTG

Date: 10.04.2019

To,

M/s Vodafone Idea Limited,
7th floor, "Konnectus",
Tower-B, Bhavbhuti Marg,
Opposite New Delhi Railway Station,
New Delhi - 110 002

Subject: Liberalisation of administratively assigned 4.4 MHz spectrum in 900 MHz band in West Bengal service area and 4.4 MHz spectrum in 1800 MHz band in each of Assam, Jammu and Kashmir, Madhya Pradesh, North East and Odisha service areas.

Sir,

It may be noted that vide this office even no. letter dated 22.03.2019, 4.4 MHz spectrum in 900 MHz band in West Bengal service area and 4.4 MHz spectrum in 1800 MHz band in each of Assam, Jammu and Kashmir, Madhya Pradesh, North East and Orissa service areas, assigned to M/s Vodafone administratively was liberalized w.e.f. 30.08.2018, subject to the payment of Rs. 28.40 Crore.

2. It may further be noted that payment of Rs. 28.40 Crore has been received in DoT.

Shitanshu Shekhar
(Shitanshu Shekhar)
Engineer

Copy to:

- (1) Director (WMO), Pushpa Bhawan, New Delhi - 110 062, for information
(2) DDG (WPF), DoT, Sanchar Bhawan, New Delhi - 1, for information and necessary action.

92
Received
A. Bhadwaj
Ashutosh Bhadwaj
Sr. Manager
VIL 9911005989





File No:1020/02/2023-WR
Government of India
Ministry of Communications
Department of Telecommunications
(Wireless Planning Finance Division – WR Section)

To
 The CGCA,
 NICF Campus,
 Ghitorni, New Delhi – 110047

Dated: xx.10.2023

Sub: Action points with respect to Review Meeting of O/o CGCA by Member(F) on 18.10.2023 – Reg.,

This is with reference to the review meeting of O/o CGCA by Member(F).

DDG (WPF) had presented a PPT (copy enclosed) with the agenda items as given below:

- i. TSP wise Outstanding SUC dues (non included in Hon'ble SC AGR judgment) as on 31.03.2023. Figures highlighted in red for M/s. BAL, VIL and RJIL are the net outstanding SUC dues which are reported by respective Assessing Authorities as recoverable from the operators vide report submitted by O/O CGCA vide email dt.04.10.2023.
 - ii. CCA wise Outstanding SUC dues as on 31.03.2023 with number of representations pending along with their aging schedule.
 - iii. CCA wise revision status of assessment of BAL and VIL in light of surrender of their MWA/MWB spectrum
 - iv. Pending CAG para replies for report 11 and 35 of 2017 from some CCA offices.
2. In this regard, Member (F) has directed following action to be initiated:
- a. With respect to the outstanding dues, there will be revision of SUC dues for M/s.VIL on grounds of revision of AGR, surrender of MWA/MWB spectrum and liberalization of spectrum in certain circles for the years not included in Hon/ble SC AGR judgement. On this issue, a letter vide No.1020/02/2023-WR, dated 10.10.2023 was sent to O/o CGCA. In addition, dues of M/s. BAL also needs to be revised on grounds of surrender of MWA/MWB spectrum and revised AGRs, if any.
 - b. In addition, dues for other operators may also be thoroughly reviewed in accordance with the guidelines/orders issued by WPF Wing from time to time so that the recoverable portion of SUC dues as on 31.03.2023 is calculated correctly. While reviewing these dues, it may be ensured that latest AGRs as finalized by LFA wing are only taken into consideration. Year wise list of finalized AGRs for BAL, BHL, VIL & RJIL is attached herewith for ready reference. It may further be ensured that SUC assessments is done only for the years not included in Hon'ble SC AGR judgement. The due date for completing this exercise is 10.11.2023. Outstanding SUC dues with interest updated upto 31.03.2023 as

detailed in Lr. No.1020/02/2023-WR, dated 04.08.2023 may be resubmitted in Annexure-I & II by 10.11.2023.

- c. Following the review of the Outstanding SUC dues for the TSP, action is to be initiated by assessing authorities for recovery of the recoverable portion (i.e. the part which is not under litigation/representation/ appeals and also not covered under moratorium) of the Outstanding SUC dues within 1 month. A compliance report may be furnished by 30.11.2023.
- d. CAG reports will be settled once full compliance of the paras as detailed in PPT attached is furnished by the CCA offices by revising their SUC demands. A report for full compliance may be furnished by 15.11.2023 positively.
- e. In addition, the representations with respect to SUC need to be monitored by O/o CGCA regularly for their timely settlement and accordingly revision of the dues.

This is issued with the approval of the Competent Authority.

Signed by Tanvika Singh
Date: 26-10-2023 11:08:30
Reason: Approved
(Tanvika Singh)
Director (WR)
Ph:011-23036821

Government of India
Ministry of Communications
Department of Telecommunications
Wireless Planning and Coordination Wing

6th floor, Sanchar Bhawan,
20, Ashoka Road, New Delhi - 110 001.

No.: L-14041/02/2023-IMT

Date: 16.11.2023

To,
M/s Bharat Sanchar Nigam Limited
Regulation Cell, Corporate Office
3rd Floor, Bharat Sanchar Bhavan
Harish Chandra Mathur Lane
Janpath, New Delhi - 110001

Subject: Assignment of frequencies to BSNL in the 700 MHz, 1800 MHz band and 2100 MHz band in view of the Cabinet decisions on 23-10-2019, 27-07-2022 and 07-06-2023.

Reference: (i) BSNL CO-RGLN/28/1/2020-REGLN/E-1834 dated 23-10-2023

Sir,

As per the decision of the Union Cabinet vide its meetings held on 23-10-2019, 27-07-2022 and 07-06-2023, the frequency spots are being assigned to you along with the effective date of assignment and date of expiry as per details mentioned in Annexure -I. Technical parameters are attached at Annexure-II. The spectrum assignments detailed in Annexure-I and Annexure-II are being done post confirmation of necessary payments by WPF Wing vide their letter dated 25-10-2023 in connection with the Demand issued by them vide letters dated 18-07-2023 and 10-10-2023.

2. The frequency assignment, contained in Annexure-I, is subject to the following:
- i. There shall be no change in the frequency assignment or any technical parameters associated therewith, as detailed in Annexure-I, without the prior written approval of Wireless Planning and Coordination (WPC) Wing, Department of Telecommunications, Ministry of Communications.
 - ii. The Government reserves the right to change the frequency spots and technical parameters at any point of time over the duration of its validity period of 20 years, whenever it is required for harmonizing bands and promoting spectrum efficiency.

Vmth

- iii. The individual carriers can be combined, provided they are not administratively assigned, to make use of new technology requiring larger bandwidth. Technology other than GSM/CDMA/WCDMA/LTE/IMT-2020 (5G technology), employed in each band in each LSA, shall be intimated to WPC Wing, wherein prior approval is required.
- iv. The Base Stations along the borders are to be registered with ITU, through WPC Wing, in order to effect co-ordination in the case of cross-border interference.
- v. The Base Stations near international border shall be so located and operated that the radio signals emanating therefrom, fade out at the international border to an extent to become unusable at the international border, but this condition may be relaxed with the agreement of the administration concerned.
- vi. The new Base Stations or changes to the existing Base Stations to employ the frequencies assigned herein shall not cause harmful interference to a station operating in accordance with the technical parameters authorised by WPC Wing.
- vii. Limits/levels on EMF exposure by Base Stations should be restricted to the limits as prescribed by the Department of Telecommunications from time to time.
- viii. An officer authorised by WPC Wing may inspect the wireless stations to verify that the said stations operate as per technical parameters assigned.
- ix. The SACFA clearance for all the Base Stations shall be obtained from WPC Wing as per the extant procedure.
- x. The wireless equipment to be employed shall be imported, if required, as per the extant procedure.
- xi. The frequency assignment shall be revoked or temporarily suspended, as the case may be, for violation of unauthorised use of frequencies and technical parameters associated therewith, breach of the conditions stipulated in the service license (UL) or non-payment of fees/charges associated with the spectrum.
- xii. The continuation of frequency assignment is subject to fulfilment of all payment terms, adherence to conditions stipulated in the relevant service licenses (UL) and the relevant provisions of the applicable Notice Inviting Applications (NIA-2022).
- xiii. For spectrum in 700 MHz band and 2100 MHz band, which is being assigned with prospective effect, the SUC rate of 0% shall be applicable in the weighted average SUC rate calculation. Further, for spectrum in 900 MHz band and 1800 MHz band, (which is being regularized now) from 29-02-2020 to 31-08-2021 and in 3 LSAs in 1800 MHz band from 29-02-2020 to 30-06-2024) an SUC rate of 3% shall be applicable till 20-06-2022 and 0% from 21-06-2022 to 30-06-2024.

(Note : On 21-06-2022, SUC order incorporating 0% SUC rate is issued & in similar manner, with the approval of competent authority, SUC rates are made applicable earlier also for 900 MHz band which was allocated with retrospective effect.)

Vinith

xiv. The above terms and conditions are without prejudice to any other action that may be taken by the Government.

3. The terms and conditions governing frequency spots assigned earlier, if any, would be as per the respective frequency assignment letters. Changeover of frequency spots, if any, shall be done at the earliest not later than 2 weeks' time from the date of issue of this letter.

Encl: Annexure I & II

Vinith

(Vineeth Kurian Mathew)
Assistant Wireless Advisor to the Govt. of India

Copy to:

1. DDG(WPF) for information and necessary action & also for intimating O/o CGCA.
2. DDG(AS) for information and necessary action.
3. Director (WMO) for information and necessary action.

Frequency carriers assigned to M/s BSNL									
Service Area	No. of blocks	Assigned Carrier Frequencies (in MHz)				BW in MHz	Effective Date	Date of Expiry	Remarks
		700 MHz band (FDD)							
		Uplink		Downlink					
		Start	Stop	Start	Stop				
Andhra Pradesh	2	738	748	793	803	10.0	16.11.2023	15.11.2043	
Madhya Pradesh	2	738	748	793	803	10.0	16.11.2023	15.11.2043	
North East	2	738	748	793	803	10.0	16.11.2023	15.11.2043	
Punjab	2	738	748	793	803	10.0	16.11.2023	15.11.2043	
Rajasthan	2	738	748	793	803	10.0	16.11.2023	15.11.2043	
Service Area	No. of blocks	Assigned Carrier Frequencies (in MHz)				BW in MHz	Effective Date	Date of Expiry	Remarks
		1800 MHz band (FDD)							
		Uplink		Downlink					
		Start	Stop	Start	Stop				
Kerala	10	1761.9	1763.9	1856.9	1858.9	2.0	29.02.2020	30.06.2024	
Odisha	10	1771.7	1773.7	1866.7	1868.7	2.0	29.02.2020	30.06.2024	
Tamil Nadu	10	1762.9	1764.9	1857.9	1859.9	2.0	29.02.2020	30.06.2024	
Service Area	No. of blocks	Assigned Carrier Frequencies (in MHz)				BW in MHz	Effective Date	Date of Expiry	Remarks
		2100 MHz band (FDD)							
		Uplink		Downlink					
		Start	Stop	Start	Stop				
Haryana	1	1974.0	1979.0	2164.0	2169.0	5.0	16.11.2023	15.11.2043	
Himachal Pradesh	1	1949.0	1954.0	2139.0	2144.0	5.0	16.11.2023	15.11.2043	
Punjab	1	1949.0	1954.0	2139.0	2144.0	5.0	16.11.2023	15.11.2043	
Uttar Pradesh (East)	1	1969.0	1974.0	2159.0	2164.0	5.0	16.11.2023	15.11.2043	
Uttar Pradesh (West)	1	1969.0	1974.0	2159.0	2164.0	5.0	16.11.2023	15.11.2043	

Vinita

No. L-14041/02/2023-IMT dated 16.11.2023

Technical Parameters

Technical parameters associated with the frequencies listed in Annexure-I including other common particulars are as given below:

i.	Licensed Service Area	<p>700 MHz: Andhra Pradesh, Madhya Pradesh, North East, Punjab, Rajasthan.</p> <p>1800 MHz: Kerala, Odisha, Tamil Nadu</p> <p>2100 MHz: Haryana, Punjab, Himachal Pradesh, Uttar Pradesh (East) and Uttar Pradesh (West)</p>
ii.	Period of validity	20 years (from the effective date as mentioned in Annexure-I)
iii.	Base Station Power (Max)	<p>2G technology: 20 W</p> <p>3G/4G technology: As per DoT Office Memorandum No. L-14010/03/2014-NTG dated 19.06.2018.</p> <p>IMT-2020 (5G technology):</p> <p>The permitted maximum RF output power/EIRP of the base station in all the frequency bands and out of band emission limits must be in compliance to the international standards of 3GPP/ITU/TEC etc. and/or international practices adopted by bodies such as CEPT/OFCOM/FCC etc, subject to meeting the EMF limits prescribed by the Department of Telecommunications from time to time.</p>
iv.	Mobile Station Power (Max)	As per TEC/ International standards
v.	Emission (as applicable)	200KG7W, 200KQ7W, 1M40G7W, 3M00G7W, 5M00G7W, 10M00G7W

Vinth

Government of India
Ministry of Communications
Department of Telecommunications
Office of Controller General of Communication Accounts
NICF Campus, Ghitorni, New Delhi-110047

No. 50-1/BG Policy/2023/BSNL LF SUC Dues

dated 23.11.2023

To,

The Pr.CCA.
Tamilnadu Circle
Department of Telecommunications
Chennai

Sub: - Non payment of License Fee and SUC for Q1&Q2-case of M/s BSNL Tamil Nadu Circle for FY 2023-24 -reg.

Ref: CCA Tamil Nadu Letter No. PCCA/TN/LF-I/2023-24/LF/BSNL-TN /9337 dated 10.11.2023

With reference to the above subject and letter under reference, please find enclosed LFA letter No. 1-34/2013/LFA-II/Part-I dated 04.11.2022 wherein it was conveyed to all Pr. CCAs & CCAs that BSNL payments for their LF and SUC Dues upto the F.Y. 2026-27 will be settled as per Cabinet decision i.e Equity conversion.

This is issued with the approval of competent authority.

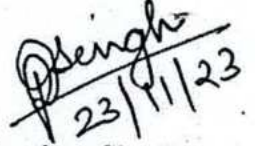
23/11/23
(Pratima Singh)
Dy. CGCA (Revenue)

Copy To,

1.All Pr.CCAs/CCAs :- for information.



सत्यमेव जयते

File No: AS-13/5/2019-Office of DIR(AS-V)-Part(1)
Government of India
Ministry of Communications
Department of Telecommunications
(Wireless Planning Finance Division – WR Section)

Dated: xx.12.2023

To

Vodafone Idea Limited,
 7th Floor, Konnectus Tower-3,
 Bhavbhuti Marg, New Delhi – 110002

Sub: Adjustment of Rs.755.52 crores pursuant to Hon'ble TDSAT order dated 15.12.2023 in MA No.114/2023 in TP 30 of 2019 – Reg.,
Ref: Your Lr. No.VIL/RCA/GB/2023/1218-001, dated 18.12.2023.

Please refer to the letter cited above.

Hon'ble Tribunal vide order dated 15.12.2023 in MA No.114/2023 in TP 30 of 2019 has directed to adjust the amount of approx. Rs.755.52 crores of M/s. VIL against LF and SUC dues.

2. The amount of Rs.755.52 crores has been first adjusted towards the outstanding SUC dues for the FYs 2019-20 to 2021-22 which are not sub-judice and balance amount towards SUC payable on self assessment basis for Q-2 of FY 2023-24.
3. The details of Circle wise/year-wise adjustment are given in the Annexure enclosed.
4. Please note that this adjustment of Rs.755.52 Crores towards the liabilities shall be subject to the outcome of TP-30 of 2019.
5. It is further intimated that your request to adjust the amount Rs.755.52 crores towards LF & SUC payable for Q-2 of 2023-24 has not been considered, as there are liabilities of the past periods as well. You are requested to pay balance amount of LF & SUC dues on self-assessment basis for Q2 of FY 2023-24 accordingly along with applicable interest.

This issues with the approval of the competent authority.

Signed by Tanvika Singh
 Date: 27-12-2023 15:40:35
 (Tanvika Singh)
 Director (WR)
 Ph:011-23036821

Copy to:

1. DDG (AS), AS Wing, DoT, Sanchar Bhawan, New Delhi for information.

Annexure

CCA wise details of the amount to be adjusted towards SUC Outstanding dues of M/s. Vodafone Idea Limited

CCA	Amount to be adjusted against 2019-20 dues			Amount to be adjusted against 2020-21 dues			Amount to be adjusted against 2021-22 dues			Amount to be adjusted for Q2 of 2023-24			
	GSM	MWA	MWB	GSM	MWA	MWB	GSM	MWA	MWB	GSM	MWA	MWB	
Andhra Pradesh	71039987	0	0	0	0	0	0	0	0	0	0	0	
Assam	87106271	19170463	7760988	10117407	0	0	0	0	0	0	0	0	
Bihar	136040283	10561630	4111867	59796364	398118	143868	27264186	0	0	0	0	0	
Delhi	184509395	0	0	0	54117578	0	0	0	0	0	0	0	
Gujarat	116018728	0	0	4783646	2604042	314888	1102293	2409169	0	55515969	88503723	0	
Haryana	30407036	1815505	0	0	13909602	0	57415703	11992964	0	0	0	0	
Himachal Pradesh	4945926	1531130	468447	47475	11237	2106	56017	14297	2532	0	0	0	
Jammu & Kashmir	5873053	1892832	634099	636910	0	0	1512017	84685	23096	0	0	0	
Karnataka	440370793	4500610	1483691	82594270	0	0	170069594	21952089	4038498	0	0	0	
Kerala	121571584	17012133	6097211	0	1671786	227968	468873	0	0	31593321	68142456	9292158	
Kolkata	0	0	0	0	0	0	0	0	0	0	0	0	
Madhya Pradesh	0	0	0	0	0	0	0	0	0	0	0	0	
Maharashtra	118469145	104689380	0	3179657	0	0	3438086	0	0	68025582	92380419	0	
Mumbai	71834185	11102109	0	0	0	0	0	0	0	46667142	48428163	0	
North East	15304984	97160	18217	0	0	0	0	2976392	558074	0	0	0	
Orissa	35241375	0	0	0	0	0	0	0	0	0	0	0	
Punjab	117342079	67910127	0	50403966	563174	0	116485204	43425887	0	0	0	0	
Rajasthan	36132715	58428550	1188202	0	0	0	2652639	620509	114745	13653051	22051935	0	
Tamilnadu	1588970899	50521839	0	1103004749	0	0	325467595	5962649	608507	33171579	87452334	9046791	
Uttar Pradesh (E)	209478860	12244196	5128363	55080492	0	0	13758914	0	0	0	0	0	
Uttar Pradesh (W)	280003457	10103552	2087369	69131348	0	0	120163196	19964430	0	0	0	0	
West Bengal	234413623	0	0	34876633	0	0	35248659	32209850	5962696	0	0	0	
Total	3905074378	371581216	28978454	1473652917	73275537	688830	875102976	141612921	11308148	248626644	406959030	18338949	
Total in Crores													7555200000
													755.52



File No: AS-13/5/2019-Office of DIR(AS-V)-Part(1)
Government of India
Ministry of Communications
Department of Telecommunications
(Wireless Planning Finance Division – WR Section)

To
The CGCA,
NICF Campus,
Ghitorni, New Delhi – 110047

Dated: 02.01.2024

Sub: Adjustment of Rs.755.52 crores pursuant to Hon'ble TDSAT order dated 15.12.2023 in MA No.114/2023 in TP 30 of 2019 – Reg.,

As part of interim order in TP-30/2019, Hon'ble Tribunal has instructed the Department to adjust the amount of Rs.755.52 crores against LF and SUC dues of M/s VIL within a timeline of 15 days.

2. Your office had communicated details of CCA/Year wise outstanding SUC dues with interest up to OCT-2023 to WPF Wing vide email dated 22.12.2023. Based on this information, Rs.755.52 crore have been centrally taken as receipt against outstanding SUC dues of M/s.VIL for FY 2019-20 to 2021-22 and towards SUC liability for Q2 of 2023-24 in 6 circles at PAO, DoT HQ (Circle wise & year wise details are as per Annexure).

3. It is requested to inform Assessing Authorities of this adjustment done at DOT HQ centrally so that they may accordingly revise the outstanding SUC dues payable by M/s.VIL. Date of credit may be taken as 15.12.2023 for calculation of interest & balance outstanding dues.

4. The revised outstanding SUC dues of M/s.VIL with interest updated upto 31.12.2023 may be intimated to this office in Proforma – I by 10.01.2024.

This issues with the approval of the competent authority.

M. Anil Singh
(Tanvika Singh) 2/01/2024
Director (WR).
Ph:011-23036821

Copy to:

1. DDG (AS), AS Wing, DoT, Sanchar Bhawan, New Delhi for information.

Annexure

CCA wise details of the amount to be adjusted towards SUC Outstanding dues of M/s.Vodafone Idea Limited

CCA	Amount to be adjusted against 2019-20 dues			Amount to be adjusted against 2020-21 dues			Amount to be adjusted against 2021-22 dues			Amount to be adjusted for Q2 of 2023-24		
	GSM	MWA	MWB	GSM	MWA	MWB	GSM	MWA	MWB	GSM	MWA	MWB
Andhra Pradesh	71039987	0	0	0	0	0	0	0	0	0	0	0
Assam	87106271	19170463	7760988	10117407	0	0	0	0	0	0	0	0
Bihar	136040283	10561630	4111867	59796364	398118	143868	27264186	0	0	0	0	0
Delhi	184509395	0	0	0	54117578	0	0	0	0	0	0	0
Gujarat	116018728	0	0	4783646	2604042	314888	1102293	2409169	0	0	55515969	88503723
Haryana	30407036	1815505	0	0	13909602	0	57415703	11992964	0	0	0	0
Himachal Pradesh	4945926	1531130	468447	47475	11237	2106	56017	14297	2532	0	0	0
Jammu & Kashmir	5873053	1892832	634099	636910	0	0	1512017	84685	23096	0	0	0
Karnataka	440370793	4500610	1483691	82594270	0	0	170069594	21952089	4038498	31593321	68142456	9292158
Kerala	121571584	17012133	6097211	0	1671786	227968	468873	0	0	0	0	0
Kolkata	0	0	0	0	0	0	0	0	0	0	0	0
Madhya Pradesh	0	0	0	0	0	0	0	0	0	0	0	0
Maharashtra	118469145	104689380	0	3179657	0	0	3438086	0	0	68025582	92380419	0
Mumbai	71834185	11102109	0	0	0	0	0	0	0	46667142	48428163	0
North East	15304984	97160	18217	0	0	0	0	2976392	558074	0	0	0
Orissa	35241375	0	0	0	0	0	0	0	0	0	0	0
Punjab	117342079	67910127	0	50403966	563174	0	116485204	43425887	0	0	0	0
Rajasthan	36132715	58428550	1188202	0	0	0	2652639	620509	114745	13653051	22051935	0
Tamilnadu	1588970899	50521839	0	1103004749	0	0	325467595	5962649	608507	33171579	87452334	9046791
Uttar Pradesh (E)	209478860	12244196	5128363	55080492	0	0	13758914	0	0	0	0	0
Uttar Pradesh (W)	280003457	10103552	2087369	69131348	0	0	120163196	19964430	0	0	0	0
West Bengal	234413623	0	0	34876633	0	0	35248659	32209850	5962696	0	0	0
Total	3905074378	371581216	28978454	1473652917	73275537	688830	875102976	141612921	11308148	248626644	406959030	18338949
Total in Crores												

Annexure-54
20/1/2024



File No:1034/05/2023-WR
Government of India
Ministry of Communications
Department of Telecommunications
(Wireless Planning Finance Division – WR Section)

To
The CGCA,
NICF Campus,
Ghitorni, New Delhi – 110047

Dated: .xx.01.2024

Sub: Payments made by M/s. Reliance Jio Infocomm related to SUC for FY 2014-15 to 2018-19 pursuant to Hon'ble Supreme Court AGR Judgement dated 24.10.2019 & 25.10.2019 – Reg.,
Ref: DoT Lr. No.1012/07/2019-WR, dated 29.01.2020

Please refer to the letter cited above (copy enclosed for reference), wherein the details of payments (Rs.46.76 crores) made by M/s Reliance JIO Infocomm for dues pertaining to SUC for FYs 2014-15 to 2018-19 pursuant to Hon'ble Supreme Court AGR Judgement dated 24.10.2019 & 25.10.2019 were given.

2. Please note that the amount of Rs.46.76 crores paid by M/s. Reliance Jio Infocomm vide letter ibid has been adjusted centrally by LFA wing vide letter No.23-24/2020/LFA/Rjio, dated 30.11.2022 (copy enclosed) against SUC dues included in Hon'ble SC AGR judgement.

3. Hence, it is requested to treat the letter circulated vide No.1012/07/2019-WR, dated 29.01.2020 as withdrawn. SUC assessments for the FYs 2014-15 to 2018-19, which are not included in Hon'ble Supreme Court AGR Judgement dated 01.09.2020, may be revised without considering the payments circulated in this letter and issued accordingly.

4. All Assessing Authorities may be further requested to submit the revised outstanding SUC dues of M/s. Reliance Jio Infocomm to this office in Proforma-I by 20.01.2024.

This is issued with the approval of Competent Authority.

Signed by Tanvika Singh
Date: 04-01-2024 13:33:16

(Tanvika Singh)
Director (WR)
Ph:011-23036821

23-4/2020/LFA/Rjio
Government of India
Ministry of Communications
Department of Telecommunications
(LFA Branch)
Sanchar Bhawan, 20, Ashoka Road,
New Delhi – 110001.

No. 23-4/2020/LFA/Rjio

Dated .11.2022

To,
M/s Reliance Jio Infocomm Ltd,
101, Saffron , Nr. Center Point,
Panchwati 5 Rasta,
Ambawadi, Ahmedabad-380006.

Sub: Revised Show Cause cum Demand notice for assessment of annual license fee dues for the F.Y 2015-16 in respect of UL (Access) (22 Circles), UL-ISP, NLD, ILD, PMRTS (22 Circles), VSAT (CUG), INSAT-MSS-R and RESALE OF IPLC of M/s Reliance Jio Infocomm Limited.

1. This is Revised Show Cause cum Demand notice is for assessment of Annual license fee for the 2015-16 in respect of UL (Access) (22 Circles), UL-ISP, NLD, ILD, PMRTS (22 Circles), VSAT (CUG), INSAT-MSS-R and RESALE OF IPLC of M/s Reliance Jio Infocomm Limited.
2. The following documents has been taken into consideration for the annual assessment of license fee.
 - a. Demand notice no. 23-4/2020/LFA/Rjio dated 31.03.2021 (PMRTS (22 Circles), VSAT (CUG), INSAT-MSS-R and RESALE OF IPLC), 07.01.2022 for UL (Access) (20 Circles), UL-ISP, NLD, ILD and 10.08.2022 for Delhi and HP.
 - b. Special Audit Report for Financial Year 2013-14 to 2017-18.
3. M/s Reliance Jio Infocomm Limited had made payment of Rs 195,18,25,683/- in Jan 2020. Out of this as per TSPs submission, Rs 46,76,05,546 pertained to SUC and rest Rs 148,42,20,137 Cr against LF dues. The dues crystallized in SC judgement dated 1.9.2020 is as under

Dues Crystallized in SC judgement	Dues as on 30.10.2019 in Rs	Dues as on Jan 2020 in Rs (at NPV of 8% p.a.)
LF dues 2013-14 (ISP dues)	53803920	54849144
LF dues 2014-15 (ISP dues)	179556226	183044384
Total LF Dues	233360146	237893528
Total SUC Dues	471937836	481105958
Total	705297982	718999486

4. As amount paid by TSP exceeds the dues crystallized in judgement, same has been adjusted in totality. Thus total payment remaining post adjustment is Rs 123,28,26,197 (Rs 195,18,25,683 less Rs 71,89,99,486). Out of this, Dues pertaining to CCA Delhi for 2010-11, 2011-12 and Rs 2012-13 has been adjusted amounting to Rs 29,43,712 as under. The remaining Amount is Rs 122,98,82,485. Out of which Rs 4,27,94,774 demand for Rs 2015-16 as detailed in para 6(a) has been adjusted, with remaining amount as Rs, 118,70,87,711. The surplus amount of Rs. 118,70,87,711 along with Rs. 3,12,35,360 (para 6(b)) has been adjusted in Next FY 2016-17.

Financial Year	License Service Area	Dues	Interest till
2010-11	ISP	5,84,579	31.01.2020
2011-12	ISP	9,32,149	31.01.2020
2012-13	ISP	14,26,984	31.01.2020
	Total	29,43,712	

5. There is no change in GR or AGR vis-à-vis assessment done vide demand notice no. 23-4/2020/LFA/Rjio dated 31.03.2021 (PMRTS (22 Circles), VSAT (CUG), INSAT-MSS-R and RESALE OF IPLC) , 07.01.2022 for UL (Access) (20 Circles), ISP, NLD, ILD and 10.08.2022 for Delhi and HP.
6. The details of assessment for the authorization /service areas for the F.Y 2015-16 in respect of UL (Access) (22 Circles), ISP, NLD, ILD, PMRTS (22 Circles), VSAT (CUG), INSAT-MSS-R and RESALE OF IPLC after adjusting surplus available in respective circle and considering lump sum payment made on 23.01.2020 is as under:

(a) Circles for which license fee is payable.:

Sl. NO.	Service Area	Due as per calculation sheet	LF Due payable as per Demand Notice with interest calculated upto 23.01.2020 (after adjustment)
1	Andhra Pradesh	1,880,151	--NIL--
2	Assam	1,582,704	
3	Bihar	1,703,704	
4	Delhi	1,519,340	
5	Gujarat	1,670,103	
6	Haryana	1,655,582	
7	Himachal Pradesh	1,576,953	
8	Jammu & Kashmir	614,590	
9	Kerala	1,578,384	
10	Kolkata	1,586,488	
11	Madhya Pradesh	1,610,937	
12	Maharashtra	1,747,622	
13	Mumbai	1,589,377	
14	North East	616,043	
15	Orissa	1,559,707	
16	Punjab	1,818,121	
17	Rajasthan	1,751,392	
18	Tamil Nadu	1,854,961	
19	Uttar Pradesh (E)	1,688,043	
20	Uttar Pradesh (W)	1,586,646	
21	West Bengal	1,686,951	
22	ILD	4,012,526	
23	NLD	5,201,028	
24	ISP	703,421	
	Total	4,27,94,774	

(b) Circles for which excess license fee is paid.:

I/3071833/2022

Sl. NO.	Service Area	Due as per calculation sheet	LF Due as per Demand Notice with interest calculated upto 23.01.2020
1	Karnataka	-31,183,903	--NIL-- (Surplus payment of Rs. 31,183,903)
2	PMRTS (22 Circles)	-3,322	--NIL-- (Surplus payment of Rs. 3322)
3	VSAT-CUG	-9,025	--NIL-- (Surplus payment of Rs. 9025)
4	Resale of IPLC	-30,085	--NIL-- (Surplus payment of Rs. 30085)
5	INSAT MSSR	-9,025	--NIL-- (Surplus payment of Rs. 9025)
Total		-31,235,360	

7. There is excess payment as detailed in para 6 (b) which shall be adjusted in subsequent years.
8. The amount as stated in this Show Cause Cum Demand Notice is subject to further revisions due to departmental assessments, Court cases etc. & is further subject to general E & O.E., with consequent interest, penalty and interest on penalty, if applicable.
9. With reference to this Show Cause Cum Demand Notice, any representation may be addressed to DDG (LFA), DoT HQ within 15 days of issue of this letter, failing which it would be presumed that the TSP has nothing to say in this matter.

Signed by Shankara Nand Mishra

Date: 30-11-2022 18:03:33

Reason: Addressed (LFA-III)

DoT, HQ

Copy to: -

I/3071833/2022

- 1 Pr.CCA/CCA/Jt. CCA Concerned for information for necessary action.
- 2 DDG (LFP)/DDG (WPF), Department of Telecom, Sanchar Bhawan, New Delhi – 110001.
- 3 Jt. CGCA (Revenue), NICF, Ghitorni, New Delhi -47.
- 4 DDG (AS), Department of Telecom, Sanchar Bhawan, New Delhi – 110001.
- 5 Concerned File.

DIGITAL
LIFERJIL/DoT/2019-20/585
23rd January, 2020

394

To
Sh. Rajiv Prakash
DDG (WPF)
Department of Telecommunications,
7th Floor, Sanchar Bhawan, 20-Ashoka Road,
New Delhi – 110001.

ADG (WR)
pld discuss.
24/01/2020
Tilvin
24.01.2020
AOC (WR)

Subject: Payment of dues pertaining to Spectrum Usage Charges for the FY 2014-15 to 2018-19 pursuant to Hon'ble Supreme Court judgment dated 24.10.2019 and orders dated 25.10.2019 in Civil Appeal No. 6328-6399 of 2015 and UOI v. Reliance Jio Infocomm Limited C.A. No. 6044 of 2016.

Reference: 1. DoT's letter No.12-26/2015/LFP (P.t II) dated 13.11.2019 and
2. LFA letter No. 1-10/2019/LFA/SC1 dated 20.01.2020.

Sir,

Pursuant to Hon'ble Supreme Court judgment dated 24.10.2019 and order dated 25.10.2019 in Civil Appeal No. 6328-6399 of 2015 and UOI v. Reliance Jio Infocomm Limited C.A. No. 6044 of 2016, Reliance Jio Infocomm Ltd. (RJIL) has made payment of Rs. 46,76,05,546 /- towards Spectrum Usage Charge dues inclusive of interest calculated up to January 2020, penalty and interest on penalty, wherever applicable.

2. The payment of Spectrum Usage Charge has been made, wherever applicable, for the period FY 2014-15 to FY 2018-19 in respect of Access Spectrum, MWA carriers and MWB carriers. The details of financial year-wise payments are enclosed herewith as Annexure and summary of these payments is as below:

SL. No.	Financial Year	SUC on Main Spectrum, MWA & MWB Charges	Interest	Penalty	Interest on Penalty	Total	UTR / Bank Reference No
1	2014-15	1,66,508	2,21,874	-	-	3,88,382	N023201043473101
2	2015-16	14,48,196	21,77,542	-	-	36,25,738	
3	2016-17	87,55,058	48,41,971	9,13,972	3,324	1,45,14,325	
4	2017-18	5,19,27,234	1,68,86,756	-	-	6,88,13,990	
5	2018-19	31,73,20,338	6,29,42,773	-	-	38,02,63,111	
Total		37,96,17,334	8,70,70,916	9,13,972	3,324	46,76,05,546	



Reliance Jio Infocomm Limited, CIN : U72900GJ2007PLC105869
Correspondence Address : D-7, Dhawandeep Building, 6 Jantar Mantar Road, New Delhi - 110001, India.
Tel : 011-43523795, Fax : 011-23340453
Registered Office : Office - 101, Saffron, Nr. Centre Point, Panchwati 5 Rasta, Ambawadi, Ahmedabad-380006, Gujarat, India.
Tel : 079-35600100
www.jio.com

393

3. It is to inform that RJIL has already paid Spectrum Usage Charge dues with applicable Interest for Q1 and Q2 of FY 2019-20 along with Licence Fee paid for Q3 of FY 2019-20 on 15.01.2020.

4. The revised statements of Revenue and License Fee are being submitted in respective Offices of CCAs. A copy of the same along with reconciliation statements will be submitted in the DoT (Hq) shortly..

Thanking you.

Yours sincerely,
For Reliance Jio Infocomm Limited,

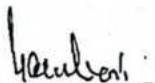
Kapoor Singh Guliani
Authorised Signatory



Encl.: As Above along with UTR details

Copy for information to:

Smt. Vandana Gupta, DDG (LFP), Department of Telecommunications, 7th Floor, Sanchar Bhawan, 20-Ashoka Road, New Delhi – 110001.

392

Reliance Jio Infocomm Limited
Details of SUC payment for F.Y. 2014-15 to 2018-19

Total						
Sl. No.	Service/Service Area	SUC on Main Spectrum MWA & MWB Charges	Interest	Penalty	Interest on Penalty	Total
1	Andhra Pradesh	3,48,20,100	69,36,891	-	-	4,17,56,991
2	Assam	73,40,178	19,00,827	-	-	92,41,005
3	Bihar	2,65,58,528	62,41,400	-	-	3,27,99,928
4	Delhi	2,40,16,609	97,66,357	-	-	3,37,82,966
5	Gujarat	2,47,79,309	46,73,675	-	-	2,94,52,984
6	Haryana	74,69,910	14,33,959	-	-	89,03,869
7	Himachal Pradesh	43,29,108	14,19,729	-	-	57,48,837
8	Jammu & Kashmir	44,45,656	10,14,155	-	-	54,59,811
9	Karnataka	2,40,98,388	49,07,808	-	-	2,90,06,196
10	Kerala	1,31,90,700	28,40,835	-	-	1,60,31,535
11	Kolkata	1,30,49,814	23,10,062	-	-	1,53,59,876
12	Madhya Pradesh	1,83,19,632	44,29,435	-	-	2,27,49,067
13	Maharashtra	2,98,92,963	61,87,624	-	-	3,60,80,587
14	Mumbai	72,41,747	16,72,970	-	-	89,14,717
15	North East	29,80,508	6,32,846	-	-	36,13,354
16	Odisha	1,10,36,609	26,80,679	-	-	1,37,17,288
17	Punjab	1,66,98,646	35,81,274	5,89,755	2,145	2,08,71,820
18	Rajasthan	1,92,35,944	48,12,571	-	-	2,40,48,515
19	Tamil Nadu	3,38,98,106	70,29,636	-	-	4,09,27,742
20	UP East	2,29,93,636	49,60,752	-	-	2,79,54,388
21	UP West	1,80,59,044	35,72,346	3,24,217	1,179	2,19,56,786
22	West Bengal	1,51,62,199	40,65,085	-	-	1,92,27,284
	Total	37,96,17,334	8,70,70,916	9,13,972	3,324	46,76,05,546



Reliance Jio Infocomm Limited
Details of SUC payment for F.Y. 2014-15

2014-15						
Sl. No.	Service/Service Area	SUC on Main Spectrum, MWA & MWB Charges	Interest	Penalty	Interest on Penalty	Total
1	Andhra Pradesh	14,097	18,702	-	-	32,799
2	Assam	15,535	21,107	-	-	36,642
3	Bihar	-	-	-	-	-
4	Delhi	-	-	-	-	-
5	Gujarat	7,914	9,238	-	-	17,152
6	Haryana	-	-	-	-	-
7	Himachal Pradesh	-	-	-	-	-
8	Jammu & Kashmir	-	-	-	-	-
9	Karnataka	16,286	21,474	-	-	37,760
10	Kerala	14,699	19,883	-	-	34,582
11	Kolkata	21,551	29,173	-	-	50,724
12	Madhya Pradesh	13,896	18,709	-	-	32,605
13	Maharashtra	7,594	8,762	-	-	16,356
14	Mumbai	3,183	2,315	-	-	5,498
15	North East	8,444	12,958	-	-	21,402
16	Odisha	17,011	25,042	-	-	42,053
17	Punjab	-	-	-	-	-
18	Rajasthan	-	-	-	-	-
19	Tamil Nadu	9,676	11,812	-	-	21,488
20	UP East	-	-	-	-	-
21	UP West	-	-	-	-	-
22	West Bengal	16,622	22,699	-	-	39,321
	Total	1,66,508	2,21,874	-	-	3,88,382



Reliance Jio Infocomm Limited
Details of SUC payment for F.Y. 2015-16

Sl. No.	Service/Service Area	SUC on Main Spectrum MWA & MWB Charges	Interest	Penalty	Interest on Penalty	Total
1	Andhra Pradesh	23,250	26,961	-	-	50,211
2	Assam	9,548	46,342	-	-	55,890
3	Bihar	74,119	1,05,606	-	-	1,79,725
4	Delhi	97,751	96,751	-	-	1,94,502
5	Gujarat	97,027	97,067	-	-	1,94,094
6	Haryana	72,208	1,06,149	-	-	1,78,357
7	Himachal Pradesh	68,589	82,697	-	-	1,51,286
8	Jammu & Kashmir	34,747	44,085	-	-	78,832
9	Karnataka	1,01,362	1,01,275	-	-	2,02,637
10	Kerala	67,491	68,034	-	-	1,35,525
11	Kolkata	1,03,349	1,59,160	-	-	2,62,509
12	Madhya Pradesh	81,423	2,30,381	-	-	3,11,804
13	Maharashtra	1,05,428	1,06,080	-	-	2,11,508
14	Mumbai	1,22,974	3,87,833	-	-	5,10,807
15	North East	15,381	25,758	-	-	41,139
16	Odisha	61,418	76,409	-	-	1,37,827
17	Punjab	-	-	-	-	-
18	Rajasthan	68,284	1,02,104	-	-	1,70,388
19	Tamil Nadu	1,12,192	1,23,075	-	-	2,35,267
20	UP East	68,313	1,27,052	-	-	1,95,365
21	UP West	-	-	-	-	-
22	West Bengal	63,342	64,723	-	-	1,28,065
	Total	14,48,196	21,77,542	-	-	36,25,738



Reliance Jio Infocomm Limited
Details of SUC payment for F.Y. 2016-17

Sls No.	Service/ Service Area	SUC on Main Spectrum, MWA & MWB Charges	Interest	Penalty	Interest on Penalty	Total
1	Andhra Pradesh	12,04,249	6,70,729	-	-	18,74,978
2	Assam	-	-	-	-	-
3	Bihar	-	-	-	-	-
4	Delhi	5,84,965	3,55,560	-	-	9,40,525
5	Gujarat	-	-	-	-	-
6	Haryana	-	-	-	-	-
7	Himachal Pradesh	-	-	-	-	-
8	Jammu & Kashmir	-	-	-	-	-
9	Karnataka	8,68,630	4,50,772	-	-	13,19,402
10	Kerala	6,48,396	3,45,216	-	-	9,93,612
11	Kolkata	-	-	-	-	-
12	Madhya Pradesh	-	-	-	-	-
13	Maharashtra	5,59,305	3,33,443	-	-	8,92,748
14	Mumbai	-	-	-	-	-
15	North East	-	-	-	-	-
16	Odisha	-	-	-	-	-
17	Punjab	11,79,509	6,56,407	5,89,755	2,145	24,27,816
18	Rajasthan	20,94,460	11,49,522	-	-	32,43,982
19	Tamil Nadu	3,35,301	1,68,524	-	-	5,03,825
20	UP East	1,35,736	77,360	-	-	2,13,096
21	UP West	6,48,434	3,64,203	3,24,217	1,179	13,38,033
22	West Bengal	4,96,073	2,70,235	-	-	7,66,308
	Total	87,55,058	48,41,971	9,13,972	3,324	1,45,14,325



388

Reliance Jio Infocomm Limited
Details of SUC payment for F.Y. 2017-18

Sl. No.	Service/Service Area	SUC on Main Spectrum, MWA & MWB Charges	Interest	Penalty	Interest on Penalty	Total
1	Andhra Pradesh	-	-	-	-	-
2	Assam	31,20,071	11,53,006	-	-	42,73,077
3	Bihar	1,28,00,971	39,85,008	-	-	1,67,85,979
4	Delhi	-	-	-	-	-
5	Gujarat	-	-	-	-	-
6	Haryana	-	-	-	-	-
7	Himachal Pradesh	23,99,939	10,42,753	-	-	34,42,692
8	Jammu & Kashmir	16,52,388	5,39,167	-	-	21,91,555
9	Karnataka	-	-	-	-	-
10	Kerala	-	-	-	-	-
11	Kolkata	-	-	-	-	-
12	Madhya Pradesh	69,69,659	23,16,456	-	-	92,86,115
13	Maharashtra	-	-	-	-	-
14	Mumbai	-	-	-	-	-
15	North East	-	-	-	-	-
16	Odisha	53,21,771	16,91,590	-	-	70,13,361
17	Punjab	-	-	-	-	-
18	Rajasthan	-	-	-	-	-
19	Tamil Nadu	65,00,258	18,35,881	-	-	83,36,139
20	UP East	66,55,834	18,79,820	-	-	85,35,654
21	UP West	-	-	-	-	-
22	West Bengal	65,06,343	24,43,075	-	-	89,49,418
	Total	5,19,27,234	1,68,86,756			6,88,13,990



Reliance Jio Infocomm Limited
Details of SUC payment for F.Y. 2018-19

Sl. No.	Service/Service Area	SUC on Main Spectrum, MWA & MWB Charges	Interest	Penalty	Interest on Penalty	Total
1	Andhra Pradesh	3,35,78,504	62,20,499	-	-	3,97,99,003
2	Assam	41,95,024	6,80,372	-	-	48,75,396
3	Bihar	1,36,83,438	21,50,786	-	-	1,58,34,224
4	Delhi	2,33,33,893	93,14,046	-	-	3,26,47,939
5	Gujarat	2,46,74,368	45,67,370	-	-	2,92,41,738
6	Haryana	73,97,702	13,27,810	-	-	87,25,512
7	Himachal Pradesh	18,60,580	2,94,279	-	-	21,54,859
8	Jammu & Kashmir	27,58,521	4,30,903	-	-	31,89,424
9	Karnataka	2,31,12,110	43,34,287	-	-	2,74,46,397
10	Kerala	1,24,60,114	24,07,702	-	-	1,48,67,816
11	Kolkata	1,29,24,914	21,21,729	-	-	1,50,46,643
12	Madhya Pradesh	1,12,54,654	18,63,889	-	-	1,31,18,543
13	Maharashtra	2,92,20,636	57,39,339	-	-	3,49,59,975
14	Mumbai	71,15,590	12,82,822	-	-	83,98,412
15	North East	29,56,683	5,94,130	-	-	35,50,813
16	Odisha	56,36,409	8,87,638	-	-	65,24,047
17	Punjab	1,55,19,137	29,24,867	-	-	1,84,44,004
18	Rajasthan	1,70,73,200	35,60,945	-	-	2,06,34,145
19	Tamil Nadu	2,69,40,679	48,90,344	-	-	3,18,31,023
20	UP East	1,61,33,753	28,76,520	-	-	1,90,10,273
21	UP West	1,74,10,610	32,08,143	-	-	2,06,18,753
22	West Bengal	80,79,819	12,64,353	-	-	93,44,172
	Total	31,73,20,338	6,29,42,773	-	-	38,02,63,111



Sl. No.	Service Area / Services	In. Favour of	Beneficiary (PAO)/A/C No.	Beneficiary (PAO) IFSC Code	Bank	NEFT Amount	DD/NEFT Date	UTR No.
1	Access - SUC	COC, PAO HEADQUARTER (077188)	10578801002	RBIS0MBPA04	HDFC	46,76,05,546	23-Jan-20	N023201043473101



396

385

PAYMENT ADVICE
RELIANCE JIO INFOCOMM LTD 840
MUM
MUM

Beneficiary's Name :COC PAO HEADQUARTER 077188
Beneficiary's Code :1234
Beneficiary's Address :

Client Ref No :RAMASAHU
Date :23/01/2020
Bank Reference No :N023201043473101

We have initiated a credit to the Account Number 10578801002 for the amount of Rs.467605546 through NEFT for the below mentioned details.

IFC Code :RBISOMBPA04
Micr Code :
Beneficiary Bank Name :
Beneficiary Brn Name :
Payment Details 1 :
Payment Details 2 :
Payment Details 3 :
Payment Details 4 :
Payment Details 5 :
Payment Details 6 :
Payment Details 7 :

This is Computer generated advice. Does not require any signature.





Government of India
Ministry of Communications
Department of Telecommunications
Sanchar Bhawan, New Delhi-110001
(WPF Wing -WR section)

NO. 1012/07/2019-WR

Dated: 29.01.2020

To
The Pr. CCA/CCA

Sub: Payment of dues pertaining to SUC for the FY 2014-15 to 2018-19 pursuant to Hon'ble Supreme Court judgment dated 24.10.2019 and orders dated 25.10.2019 in Civil Appeal No. 6328 to 6399 of 2015 and UOI v/s Reliance Jio Infocomm Ltd. CA No. 6044 of 2016.

Kindly find enclosed letter No. RJIL/DoT/2019-20/585 dated 23.01.2020 from M/s Reliance Jio Infocomm Ltd. giving the details of payment made for dues pertaining to Spectrum Usage Charges for FY 2014-15 to 2018-19 pursuant to Hon'ble Supreme Court judgment dated 24.10.2019 and order dated 25.10.2019 in Civil Appeal No. 6328 to 6399 of 2015 (AGR case).

This is for your information and further necessary action.

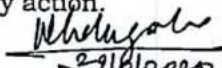
29/01/2020
(Khandagale Dhammapal Anil)
ADG (WR)
Tel: 011 2303 6362

Enclosed: As above.

Copy to: The Jt.CGCA (Revenue) O/o CGCA, NICF Campus, Ghitorni, New Delhi- 110047.

Annexure-A

Details of SUC dues not included in Hon'ble Supreme Court Judgement for M/s.Unitech

Circle	Financial Year	As per details given in your Lr. dated 09.02.2024		Total demand as per DoT		Remarks
		Total Demand Amount	Demand notice Date	Total demand Amount	Demand notice Date	
Assam	2008-09	0	26-Jul-23	0	26.07.2023	
Assam	2010-11	9455934	26-Jul-23	95,45,013	21.03.2024	Revised demand issued on 21.03.2024 enclosed
Assam	2011-12	6683	26-Jul-23	6,683	26.07.2023	
Assam	2012-13	4952792	29-Nov-23	49,52,792	29.11.2023	
Haryana	2008-09	0	21-Jul-23	0	20.07.2023	
Haryana	2009-10	5990	21-Jul-23	6,345	20.07.2023	
Haryana	2010-11	8018111	21-Jul-23	85,49,194	20.07.2023	Revised amount is with Interest calculated upto 31.12.2023 on demand amount
Haryana	2011-12	238798	21-Jul-23	2,54,613	20.07.2023	
Haryana	2012-13	4051412	21-Jul-23	43,19,758	20.07.2023	
Jammu & Kashmir	2008-09	0	20-Jul-23	0	12.12.2023	
Kerala	2008-09	0	21-Jul-23	0	27.07.2023	
Madhya Pradesh	2008-09		31-Mar-23	0	31.03.2023	
Maharashtra	2008-09	0	23-Jul-23	0	18.08.2022	
Maharashtra	2009-10	0	23-Jul-23	0	18.08.2022	
Maharashtra	2010-11	-	23-Jul-23	0	18.08.2022	
Mumbai	2008-09			0	15.11.2019	
Mumbai	2009-10	-	20-Jun-23	0	20.06.2023	
Mumbai	2010-11	7,15,64,779	20-Jun-23	7,43,72,301	20.06.2023	Interest calculated 31.12.2023
Mumbai	2011-12	16,79,24,683	18-Dec-23	16,79,24,683	18.12.2023	
Mumbai	2012-13	24,68,74,837	20-Jun-23	25,65,59,857	20.06.2023	Interest calculated 31.12.2023
North East	2008-09	0	26-Jul-23	0	26.07.2023	
North East	2009-10	0	26-Jul-23	0	26.07.2023	
North East	2010-11	89,50,593	26-Jul-23	94,82,429	26.07.2023	Revised amount is with Interest calculated upto 31.12.2023 on demand amount-
North East	2011-12	3397	26-Jul-23	3,599	26.07.2023	
North East	2012-13	4110383	26-Jul-23	43,54,618	26.07.2023	
Odisha	2008-09	-	19-Jul-23	0	19.07.2023	
Odisha	2009-10	-	19-Jul-23	0	19.07.2023	
Odisha	2010-11	3,40,32,786	19-Jul-23	3,40,32,786	19.07.2023	
Odisha	2011-12	6,38,79,081	19-Jul-23	6,38,79,081	19.07.2023	
Punjab	2008-09	0	28-Nov-23	0	28.11.2023	
Punjab	2009-10	0	28-Nov-23	0	28.11.2023	
Punjab	2010-11	86,26,462	28-Nov-23	86,26,462	28.11.2023	
Punjab	2011-12	20,915	28-Nov-23	20,915	28.11.2023	
Punjab	2012-13	51,20,612	28-Nov-23	51,20,612	28.11.2023	
Rajasthan	2007-08	0	17-Jul-23			No assessment by Circle in 2007-08 as spectrum allotted in Dec-2008.
Rajasthan	2008-09	-	17-Jul-23	0	18.07.2023	
Rajasthan	2009-10	1,34,002	17-Jul-23	1,41,964	18.07.2023	Revised amount is with Interest calculated upto
Rajasthan	2010-11	8040287	17-Jul-23	85,18,033	18.07.2023	

Circle	Financial Year	As per details given in your Lr. dated 09.02.2024		Total demand as per DoT		Remarks
		Total Demand Amount	Demand notice Date	Total demand Amount	Demand notice Date	
Rajasthan	2011-12	31654	17-Jul-23	33,535	18.07.2023	31.12.2023 on demand amount
Rajasthan	2012-13	4304527	17-Jul-23	45,60,298	18.07.2023	
UP East	2008-09	0	08-Aug-23	0	10.08.2023	
West Bengal	2010-11	9,18,08,017	10-Aug-23	9,57,12,360	28.02.2024	Revised demand issued on 28.02.2024 enclosed
West Bengal	2011-12	168741121	10-Aug-23	16,87,41,121	10.08.2023	
West Bengal	2012-13	172738614	10-Aug-23	17,27,38,614	10.08.2023	
Grand total		1,08,36,36,470		1,10,24,57,666		
In cr		108.36		110.25		

Circle	Financial Year	As per details given in Lr. No.		Total demand as per DoT		Remarks
		Total Demand Amount	Demand notice Date	Total demand Amount	Demand notice Date	
Assam	2009-10	-55773	26-Jul-23	0	21.03.2024	Surplus amount adjusted in 2010-11
Tamilnadu	2008-09	-2161	31-Jul-23	-11170	28.02.2024	Revised demand issued on 28.02.2024 enclosed
West Bengal	2008-09	-11536	29.11.2023	0	28.02.2024	Revised demand dated 28.02.2024 enclosed
West Bengal	2009-10	-3,81,956	29.11.2023	0	28.02.2024	Revised demand issued on 28.02.2024 enclosed
Grand total		-4,51,426		-11170		
In cr		-0.05		0.00		

Note:

- 1.All dues are provisional in nature and subject to further revisions due to departmental assessments, CAG audits, Special Audits, Court Cases etc.,
2. Please note that interest shall be payable as on date of clearing of outstanding dues, as per License conditions/2nd moratorium conditions.

Annexure-B

CCA wise details of encashment of SUC BGs of M/s. Unitech and adjustment towards SUC dues										
Circle	BG No.	Amount	FBG/ PBG	LF/ SUC	Amount Adjusted	Adjusted against LF/ SUC	Details of encashed BG adjustment		Balance Encashed Amount with CCA's which is not adjusted	
							FY against which Amount adjusted	Amount adjusted		
AP	NIL	NIL	NIL	NIL	NIL	NIL	NIL	NIL	NIL	
Assam	503LG1086/12	100000	FBG	SUC	100000	SUC	2008-09	91935	NIL	
							2010-11	8065		
Bihar	NIL	NIL	NIL	NIL	NIL	NIL	NIL	NIL	NIL	
Chhattisgarh	503LG1083/12	400000	FBG	SUC	503	SUC	2008-09	503	399497	
Delhi										
Gujarat	503LG1087/12	41700000	FBG	SUC	0	0	0	0	41700000	
Haryana	503LG1079/12	200000	FBG	SUC	200000	SUC	2008-09	98773	0	
							2009-10	101227		
HP	503LG1085/12	200000	FBG	SUC	0				200000	
J&K	503LG10802/12	400000	FBG	SUC	115675	SUC	2008-09	115675	284325	
							2008-09	NIL		
Jharkhand	503LG1084/12	40600000	FBG	SUC	NIL	NIL	NIL	NIL	40600000	
Karnataka	503LG1073/12	20607061	FBG	SUC	0	0	0	0	20607061	
Kerala	503LG1090/12	5323752	FBG	SUC	80	SUC	2008-09	80	5323672	
							2008-09	NIL		
Kolkata	503LG1088/12	15386000	FBG	SUC	NIL	NIL	NIL	NIL	15386000	
MP	NIL	NIL	NIL	NIL	NIL	NIL	NIL	NIL	NIL	
Maharashtra	503LG1078/12	60900000	FBG	SUC	37966262	SUC	2008-09	78568	22933738	
							2009-10	1167396		
							2010-11	36720298		
Mumbai	503LG1072/12	19000000	FBG	SUC	19000000	Adjusted against SUC	2009-10	1642239	NIL	
							2010-11	17357761		
MF-I	503LG1077/12	100000	FBG	SUC	100000	SUC	2008-09	91112		

Circle	BG No.	Amount	FBG/ PBG	LF/ SUC	Amount Adjusted	Adjusted against LF/ SUC	Details of encashed BG adjustment		Balance Encashed Amount with CCA's which is not adjusted
							FY against which Amount adjusted	Amount adjusted	
							2010-11	8888	0
NE-II	NIL	NIL	NIL	NIL	NIL	NIL	NIL	NIL	NIL
Odisha	503LG1070/12	9313758	FBG	SUC	9313758	SUC	2008-09	15	0
							2010-11	9313743	
Punjab	503LG1076/12	200000	FBG	SUC	200000	SUC	2008-09, 2009-10 & 2010-11	200000	0
Rajasthan	503LG1080/12	162000	FBG	SUC	162000	SUC	2008-09	112447	0
Rajasthan							2009-10	49553	0
Tamilnadu	503LG1075/12	17500000	FBG	SUC	0	0	-	0	17500000
Telangana	503LG1071/12	40985935	FBG	SUC	0	0	0	0	40985935
UP(E)	503LG1089/12	87100000	FBG	SUC	79768	SUC	2008-09	79768	87020232
UP(W)	503LG1081/12	51600000	FBG	SUC	0	NA	NA	NA	51600000
Uttarakhand	NIL	NIL	NIL	NIL	NIL	NIL	NIL	NIL	NIL
West Bengal	503LG1074/12	31639396	FBG	SUC	31639396	SUC	2010-11	31639396	0
	Total	443417902			98877442			98877442	344540460
	Total in Crores	44.34			9.89			9.89	34.45



सत्यमेव जयते

**File No:1020/02/2023-WR
Government of India
Ministry of Communications
Department of Telecommunications
(Wireless Planning Finance Division – WR Section)**

Dated: xx.01.2024

OFFICE MEMORANDUM

Sub: Minutes of the Review Meeting on recovery of Outstanding SUC dues held on 09.01.2024_ – Reg.,

The undersigned is directed to forward herewith the minutes of the review meeting held through VC under Chairmanship of Member (F) on 09.01.2023 at 15.30 hrs in Committee Room, 2nd Floor, Sanchar Bhavan, New Delhi-110001.

2. This has approval of the Competent Authority.

Signed by Tanvika Singh
Date: 12-01-2024 16:51:01
(Tanvika Singh)
Director (WR)
Ph:011-23036821

Copy to:

1. PSO to Member(F), DCC
2. PPS to CGCA, NICF Campus, New Delhi
3. PPS to Addl CGCA, NICF Campus, New Delhi
4. PSO to Advisor(F)
5. Sr. DDG (LFA)
6. DDG (LFP)
7. Jt. CGCA (Revenue), O/o CGCA with a request to circulate the same to all the Pr.CCAs/CCAs.

**MINUTES OF THE REVIEW MEETING ON RECOVERY OF OUTSTANDING
SUC DUES HELD ON 09.01.2024**

A review meeting was conducted on outstanding SUC dues through VC in Committee Room, 2nd floor on 09.01.2024 under the chairmanship of Member (F).

2. The meeting was attended by the officers mentioned in Annexure-1.
3. The agenda of the meeting is given hereunder:
 - a. Review of status of outstanding SUC dues
 - b. Action taken by Assessing Authorities for realization of the dues which are recoverable
4. In opening remarks, Member(F) expressed his serious concern over non finalization of the outstanding SUC dues and realization of recoverable dues by the Assessing Authorities. Member (F) emphasized that the recovery of outstanding SUC dues is of utmost importance and the task mandated to the Assessing Authorities is to assess, raise demand notes and realise revenue on annual basis. Thus, Member (F) directed all the Assessing Authorities to ascertain the outstanding SUC dues correctly, segregate sub-judice amount and take all the necessary measures to recover balance dues as per license agreement.
5. DDG (WPF) illustrated possible issues which have been disputed by licensees either in court of law or otherwise. Same are mentioned hereunder:
 - i. Sub-judice cases
 - Additional SUC charges in cases of sharing of spectrum (TP-01/2023)
 - Charging of Floor SUC amount (TP-09/2017)
 - SUC rate for 3G (2100 MHz) spectrum acquired in 2010 Auction in cases of expiry of licenses (TP-28/2016)
 - MWA/MWB rates (2002 or 2006/2008 rates) (CA-8232/2019)
 - ii. Other issues
 - Item at Sl. No.8 of Revenue Stt: Revenue from Sale and Lease of Bandwidth
 - Apportionment of IUC charges (Revenue & Deductions) between Wireline & Wireless Revenue
 - Zero BWA revenue but miscellaneous incomes reported
 - Negative AGR in some quarters taken as ZERO AGR
 - SUC rate in cases of merger of TSPs
 - Pending Appeals
6. The above issues are detailed in Annexure-2 for taking necessary action in such cases/issues.
7. Subsequently, the data sheets containing CCA-wise/TSP wise/Year-wise SUC outstanding dues of M/s. BAL & M/s. RJIO were presented by DDG (WPF). DDG (WPF) stated that the data related to outstanding SUC dues presented is based on the information submitted by Assessing Authorities which in turn compiled and forwarded by O/o CGCA. The

SUC outstanding dues are categorized as "Demand", "Sub-judice amount" & "Balance (recoverable amount)".

8. Member (F) sought reasons for pendency in recoverable outstanding SUC dues from all the Assessing Authorities and noted that certain CCAs had huge pendency of recoverable outstanding SUC dues such as Karnataka, Jharkhand, Gujarat, Maharashtra, etc.. Some CCAs viz Kolkata, Jammu & Kashmir, Madhya Pradesh, Assam, HP etc. have made commendable performance on this count. Member (F) re-iterated need for expeditious segregation of outstanding SUC dues which is free from any litigation in any court of law and its realisation in time bound manner in accordance with provisions in Licence Agreement.

9. CCA-wise pendency regarding no. of appeals by licensee along with amount under appeal was also discussed. Member (F) emphasized need for co-ordination between Assessing Authorities and Appellate Authorities. All CCAs were directed by Member (F) to take necessary action for disposal of the appeals on a priority basis. Member(F) reiterated that prescribed timelines in this regard should be adhered to.

10. Member (F), in order to have proper monitoring of SUC dues realization work and for reducing the pendency of recoverable outstanding SUC dues, directed following:

- i. CGCA should include review of outstanding dues in Zonal level meeting and action taken report should be sent to DOT HQ
- ii. At Zonal level, Pr. CCAs to conduct meetings with the CCAs under their jurisdiction to sensitize them on the early recovery of recoverable dues.

11. Member (F) also felt the need for active co-ordination of Assessing Authorities with TSPs/Licensees and suggested holding informal/formal meetings with concerned licensee for realization of the outstanding SUC dues and to initiate suitable action in accordance with UL/UASL agreement for recovery of dues except:

- a. Dues covered in AGR judgment of Hon'ble SC
- b. Sub judice dues (i.e. pending court cases/CIRP) to avoid contempt of court in any case.
- c. Dues covered under 2nd moratorium offered by DoT and accepted by Licensee

12. In end, DDG (WPF) summarized following actions points:

- Adjustment of central credits adjustment of M/s. VIL dues as per the guidelines issued vide Lr.No. AS-13/5/2019-Office of DIR(AS-V)-Part(1), 02.01.2024 and endorsed by O/O CGCA vide email dated 04.01.2024.
- Reversal of payment/credits by M/s. RJIL for years not included in Hon'ble SC AGR Judgement, if any, as per the guidelines issued vide Lr. No:1034/05/2023-WR, dated 04.01.2024 and endorsed by O/O CGCA vide email dated 05.01.2024.
- Surplus adjustment (only in case of surplus amounts as per assessment order) as per extant guidelines.
- Disposal of appeals as per prescribed time frame through a speaking order
- Realisation of recoverable amounts (which are not sub-judice)
- Completion of SUC Assessment for 2022-23 by 31/01/2024

13. DDG(WPF) further intimated all Assessing Authorities that spectrum holding of all the licensees has been updated in SARAS and requested all to check & certify it by 31/01/2024. In event of any discrepancy, it may be brought to the notice of Director(WR) at virender.vats@gov.in and singh.tanvika@gov.in.

14. The meeting ended with a vote of thanks to all the participants.

(Tanvika Singh)
Director (WR)
Ph:011-23036821

Annexure-1

- i. CGCA
- ii. Addl CGCA
- iii. Advisor(F)
- iv. Sr. DDG (LFA)
- v. Jt. CGCA (Revenue)
- vi. All Pr.CCAs/CCAs
- vii. DDG (LFP)
- viii. DDG (WPF)
- ix. Director (LFP-I)
- x. Director (LFP-II)
- xi. Director (LFA-II)
- xii. Director (LFA-III)
- xiii. Director (WR)

Annexure-2
Issues related to SUC Assessment

Court Cases:

1. Additional SUC charges in cases of Sharing:

The matter is sub judice under TP-01/2023, filed by M/s. Reliance Jio. The matter of contention is applying additional SUC rate of 0.5% in cases of spectrum sharing on band in which sharing is taking place or on overall weighted average.

TDSAT vide order dated 09.01.2023 has stayed the operation of order dated 11.10.2022 (i.e. order issued for charging additional SUC rate of 0.5% on overall weighted average in cases of sharing).

2. Charging of Floor SUC amount:

The matter is sub judice under TP-09/2017 filed by M/s BAL. The matter of contention is applying floor amount of SUC in accordance with SUC charging order dated 12.08.2016.

TDSAT vide Order dated 27.12.2021 in TP-9 of 2017 has quashed the "Clause (iii) of the SUC Order 12.08.2016 (referred in Para-3 in order No.L-14010/01/2021-NTG, dated 21.06.2022) regarding floor amount of SUC"

Presently, the TDSAT order has been challenged by DOT in Hon'ble Supreme Court.

3. SUC rate for 3G (2100 MHz) spectrum acquired in 2010 Auction in cases of expiry of licenses:

The matter is sub judice under TP-28/2016, filed by COAI, Bharti Airtel and Vodafone Idea Ltd. The matter of contention is charging SUC rate @ 3% or 5% for 3G (2100 MHz) spectrum acquired in 2010 auction in cases where the administrative spectrum has expired.

As per the SUC order dated 12.08.2016, the SUC rate will be 5% in r/o the Licensees whose license has expired.

The interim order dated 30.05.2016 issued by TDSAT is made applicable to Kolkata & Himachal Pradesh Circles and all the other circles are applying 5% of SUC rate for 3G (2100 MHz) spectrum in cases whose license has expired (i.e. where the administrative spectrum has expired). However no coercive action is to be taken.

4. MWA/MWB rates in cases of pending for reassignment:

The matter is sub judice under CA No.8232/2019 filed by M/s VIL. The matter of contention is charging 2002 rates or 2006 rates on MW carriers pending for re-assignment.

Hon'ble TDSAT in its order dated 13 Mar, 2019 allowed DOT to charge as per 2006/2008 order from prospective date. DOT appealed against this order in Hon'ble Supreme Court vide C.A No.8232/2019 which in its order dated 08.11.2019 stayed the operation of TDSAT order dated 13.03.2019 in TP No.38 of 2017.

MWA/MWB links were re-assigned to M/s BAL on its migration from UASL to UL with Access Service Authorisation in respective LSAs subject to outcome of this case.

However, SUC is payable as per 2006 order w.e.f. date of its Access Service Authorisation under UL.

Other Issues

1. Considering the revenue related to Leased line as Wireless Revenue:

The matter of contention is related to levy of SUC on "Revenue from Sale and Lease of Bandwidth".

As per the existing guidelines the "Revenue from Sale and Lease of Bandwidth", to be reported at Sl. No.8 in statement of revenue, is treated as miscellaneous revenue and is being apportioned between wireline & wireless revenue. Position of DOT is very clear on this issue.

2. Apportionment of IUC charges (Revenue & Deductions) between Wireline & Wireless Revenue:

Presently, revenue & deductions of IUC are being apportioned based on Wireline & Wireless revenue as per the existing guidelines.

TSPs are representing for considering the actual revenue & deductions of IUC submitted in the Annexure along with the "Statement of Revenue" instead of apportioning.

Position of DOT is very clear on the subject. Revenue Statement, which forms integral part of License Agreement, does not provide reporting of revenue & deductions of IUC separately for Wireline & Wireless. Hence, present procedure of apportioning it between wireline & wireless is correct.

3. Zero BWA revenue but miscellaneous incomes reported.

Assessing Authorities are applying SUC rate on total AGR (including Misc Income) whereas licensor is contending that there should not be any SUC as revenue from BWA spectrum is Zero.

SUC is charged on Applicable AGR which is inclusive of miscellaneous revenue. Hence, assessment has been done correctly.

4. Negative AGR in some quarters taken as ZERO AGR instead of cumulating on Annual basis.

This issue has been clarified vide DOT order No:1-22/2016-LFP-I/Part, dated 15.11.2023. Assessing Authorities may assess accordingly.

5. SUC rate in cases of merger of TSPs:

The relevant para of Merger guidelines issued vide Lr. No.20-281/2010-AS-I (Volume-VII), 20.02.2014 is reproduced hereunder:

"J) The Spectrum Usage Charge (SUC) as prescribed by the Government from time to time, on the total spectrum holding of the resultant entity shall also be payable"

Based of the above guidelines, various scenarios were clarified vide Lr. No.1000/10/2022-WR, dated 19.12.2022. Assessments may be done accordingly.

Government of India
Ministry of Communications
Department of Telecommunications
Sanchar Bhawan, 20, Ashoka Road,
New Delhi – 110001.

No. 1-6/2023/SARAS/SUC Module

Date: 11.01.2024

To,
All Pr. CCAs/CCAs

Sub : Rollout of upgrades in SUC Module in SARAS – Regarding

It is to inform that upgrades in SUC Module in SARAS had been rolled out in Pilot Phase – I Circles namely Karnataka, Madhya Pradesh, Punjab & Tamil Nadu since 22.11.2023. Following their feedback, all critical issues have been resolved. The module has also been implemented in Gujarat and Kolkata circle.

In its continuation, I am directed to convey that SUC Demand Notice to TSPs from FY 2022-2023 onwards may be issued via SARAS.

For any issues related to SUC module, Ms. Gauri Kadam, AAO (LFA-III), DoT HQ Contact No. 9167620424 may be contacted or mail may be sent to support.saras-dot@gov.in.

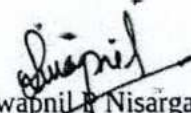
Swapnil Nisargan
ACAO (LFA-III)

Email id : swapnil.pn@gov.in
Mobile No. 9975676734

Copy for information to :

1. PS to Member (F)
2. PS to Advisor (F)
3. Sr. DDG(LFA)/DDG(LFP)/DDG(WPF)
4. Addl CGCA/ Jt. CGCA (Revenue)

Government of India
Ministry of Communications
Department of Telecommunications
Wireless Planning and Coordination Wing

6th floor, Sanchar Bhawan,
20, Ashoka Road, New Delhi - 110 001.

No.: L-14041/01/2020-NTG

Date: 15.01.2024

To,
M/s Bharat Sanchar Nigam Limited
Regulation Cell, Corporate Office
3rd Floor, Bharat Sanchar Bhavan
Harish Chandra Mathur Lane
Janpath, New Delhi - 110001

Subject: Regularisation of the spectrum of BSNL, post the expiry of service license - reg.

Reference: BSNL CO-RGLN/28/1/2020-REGLN/E-1834 dated 23-10-2023.

Sir,

I am directed to refer the above letter dated 23-10-2023 and state that, after the receipt of necessary payment from BSNL, the competent authority has approved the regularisation of the spectrum held by BSNL in the 900 MHz and 1800 MHz bands, as mentioned in Annexure -I, for the period from 29-02-2020 to 31-08-2021.

2. Further, for the above-mentioned regularized spectrum in 900 and 1800 MHz bands, an SUC rate of 3% shall be applicable from 29-02-2020 to 31-08-2021.

Encl: Annexure I

Vineeth
(Vineeth Mathew)

Assistant Wireless Advisor to the Govt. of India

Copy to

1. DDG(WPF) for information and necessary action
2. Director(WMO) for information.

- Dir (WCR)

Annexure-I

The details of the spectrum held by BSNL which is regularised for the period from
29-02-2020 to 31-08-2021

LSA	900 MHz band (in MHz)	1800 MHz band (in MHz)
Andhra Pradesh	0.6	3.8
Assam	1.2	3.8
Bihar	1.2	0
Gujarat	1.2	0
Haryana	0.6	3.8
Himachal Pradesh	0.6	3.8
Jammu and Kashmir	3	0
Karnataka	0.6	3.8
Kerala	0	1.8
Kolkata	1.2	0
Madhya Pradesh	1.2	3.8
Maharashtra	1.2	0
North East	1.2	3.8
Odisha	0.6	1.8
Punjab	1.2	0
Rajasthan	0.6	0
Tamil Nadu	0.6	1.8
Uttar Pradesh (East)	1.2	3.8
Uttar Pradesh (West)	1.2	3.8
West Bengal	0.6	1.8

Vinith
15-1-24

मनोज धर्मराजन, आई पी एंड टी ए एफ एम
वरिष्ठ उप. महानिदेशक

(लाइसेंसिंग वित्त मूल्यांकन)

MANOJ DHARMARAJAN, IP & TAFS
Senior Dy. Director General
(Licensing Finance Assessment)



भारत सरकार
संचार मंत्रालय
दूरसंचार विभाग

GOVERNMENT OF INDIA
MINISTRY OF COMMUNICATIONS
DEPARTMENT OF TELECOMMUNICATIONS

F. No. 27-8/LFA/2021/Misc

Date: 16.01.2024

Respected ma'am

As you are aware, DVRs of operators are to be finalized by 31st December of the following financial year i.e within the prescribed timeline. In this regard, instances have come to our notice wherein CCAs are revising the DVR after the prescribed timelines for DVR finalization or even after the settlement of the outstanding dues by TSPs. For instance, certain CCAs have even re-opened the DVR of FY 2019-20 now, i.e after a lapse of 3 years. This is neither envisaged nor to be encouraged at all.

Hence, I wish to reiterate that Deduction Verification Report shall not be revised for the cases where AGR is finalized and outstanding dues are already settled by the TSPs.

It is requested to follow the prescribed timeline for finalization of DVR (attached). The representation of TSPs on DVR, if any, are also to be disposed off within the timeline i.e 31st December. All Pr. CCA's /CCA's may kindly be informed accordingly.

with warm regards

Yours sincerely,

[Signature]
16/1/24

(Manoj Dharmarajan)

Ms. Anuradha Joshi,
CGCA.

Annexure G: Timelines for submission of documents and process of deduction verification

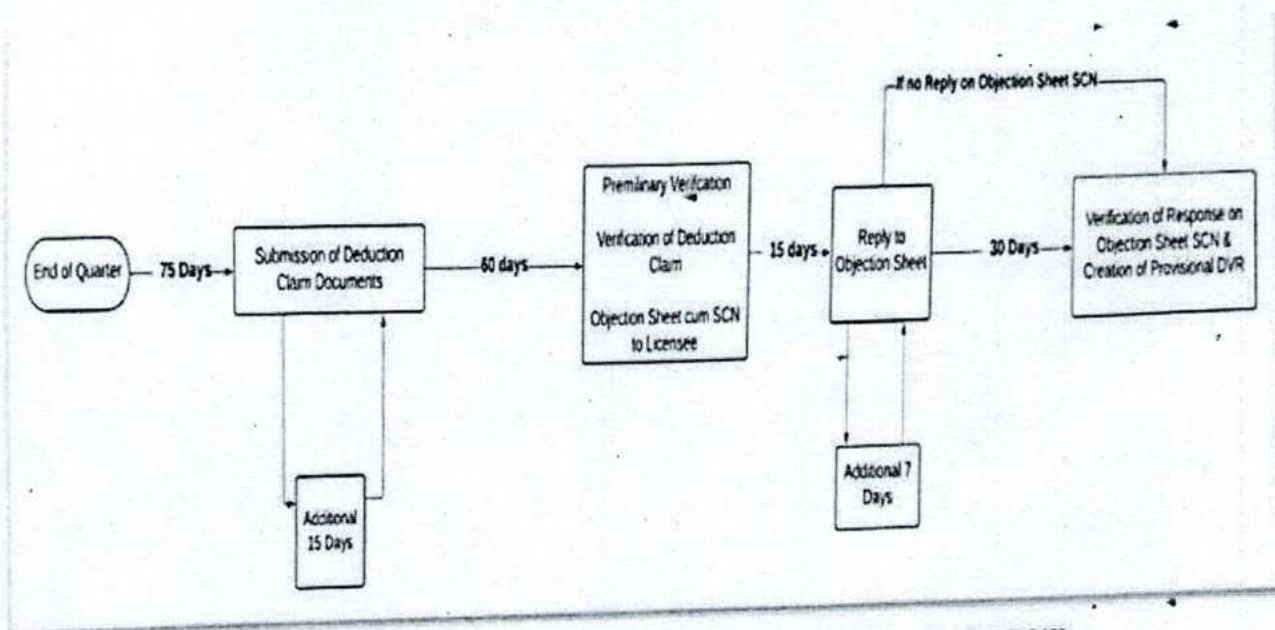

Fig (above): Timeline for preparation of Provisional (Quarterly) DVR

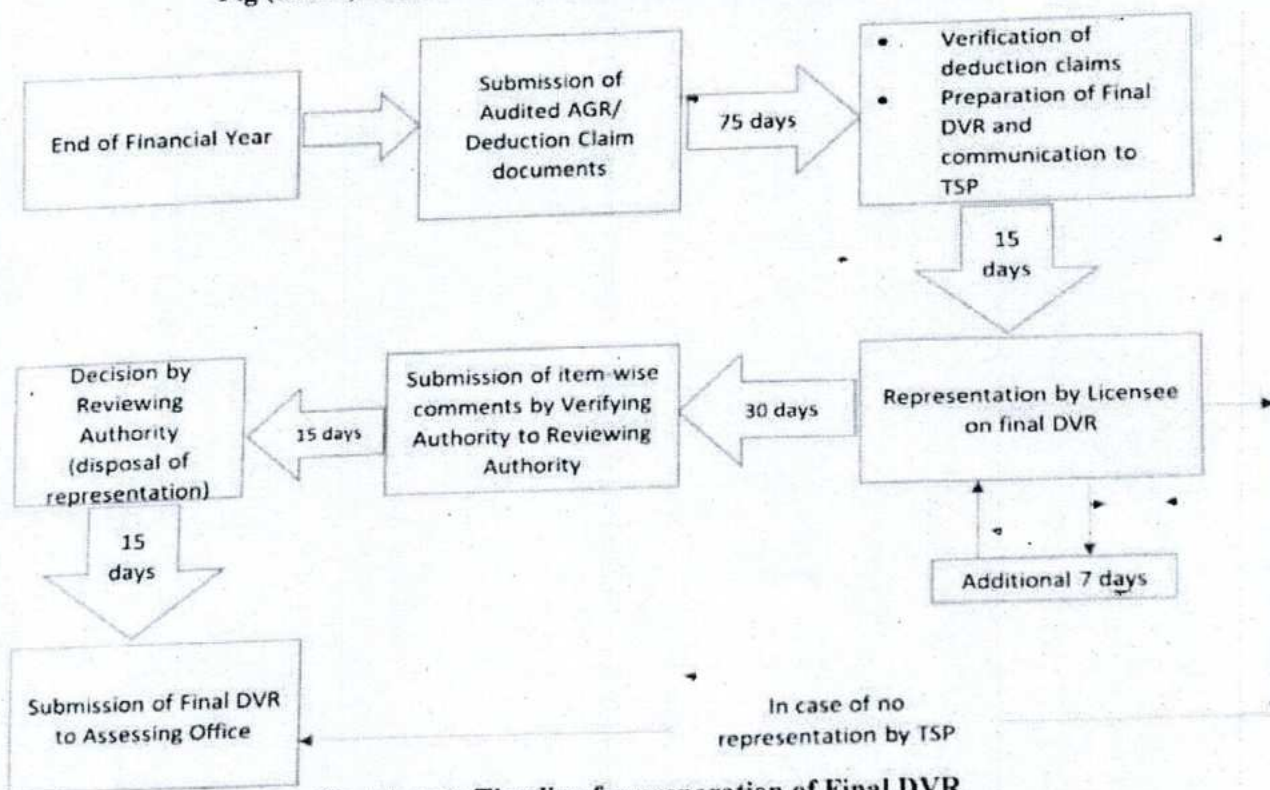

Fig (above): Timeline for preparation of Final DVR
(In case of no representation, Final DVR to be submitted to Assessing Office within 90 days of receipt of Audited Annual documents or 31st December, whichever is earlier)

Government of India
Ministry of Communications
Department of Telecommunications
Office of Controller General of Communication Accounts
NICF Campus, Ghitorni, New Delhi-110047

No:50-5\DVR\TSPs\2024

Dated 17.01.2024

To,

All Pr. CCAs/CCAs

Sub: Regarding timeline for the DVR Finalization

Kindly find enclosed DO No. 27-8/LFA/2021/Misc dated 16.01.2024 received from Sr. DDG(LFA) of DoT HQ regarding timelines for the DVR finalization.

It is intimated the DVRs of operators are to be finalized by 31st December of the following financial year i.e. within the prescribed timeline. It came to notice that CCAs are revising the DVR after the prescribed timelines for DVR finalization or even after the settlement of the outstanding dues by TSPs. Certain CCAs have reopened the DVR of FY 2019-20 now, i.e. after a lapse of 3 years. This is neither envisaged nor to be encouraged at all.

In this regard, I am hereby directed to inform you that DVR shall not be revised for the cases where AGR is finalized, and outstanding dues are already settled, and it is also requested to follow the prescribed timeline for finalization of DVR. The representation of TSPs on DVR, if any are also to be disposed off within the timeline i.e. 31st December.

This issues with the approval of Competent Authority.

Signed by

Christeena Joy

Date: 22-01-2024 14:58:16
Asstt. CGCA (Revenue)

**Government of India
Ministry of Communications
Department of Telecommunications
(Licensing Finance Assessment Wing)
Sanchar Bhawan, 20 Ashoka Road, New Delhi -110001**

Show Cause Notice

No.1-14/2024/LFA/VIL

Dated:25.01.2024

To

M/s Vodafone Idea Limited,
7th Floor, Konnectus Tower 3, Bhavbhuti Marg,
Opp. New Delhi Railway Station (Ajmeri Gate Side),
New Delhi – 110001.
Ph: 011 23210134.

Subject: Show Cause Notice for short payment of Quarterly License Fee dues for Quarter-2 of FY 2023-24 on self-assessment basis in respect of M/s Vodafone Idea Limited.

Ref: (i) Representations dated 18.12.2023 & 28.12.2023 received from your respective

office.

(ii) DoT's letter No.AS-13/5/2019-Office of DIR (AS-V)-Part (1) dated 27.12.2023

This is regarding short payment of quarterly License Fee dues for Q2 of FY 2023-24 in respect of M/s Vodafone Idea Limited as per license agreement.

2. The payment terms are governed by Clause 20.4 of Unified License Agreement and equivalent clauses of other license agreements. Vide Clause 20.4 of UL agreement, it is stated that –

*"License Fee shall be payable in four quarterly installments during each financial year (FY). Quarterly installment of license fee for the first three quarters of a financial year shall be paid **within 15 days of the completion of the relevant quarter**. The AGR based license Fee shall be paid by the Licensee on the basis of revenue on accrual basis for the quarter, duly certified with an affidavit by a representative of the Licensee who is authorized by the Board*

Resolution coupled with General Power of Attorney. However, for the last quarter of the financial year, the Licensee shall pay the License Fee by 25th March on the basis of expected revenue for the quarter, subject to a minimum payment equal to the revenue share paid for the previous quarter."

3. M/s VIL has made short payment of the quarterly License Fee (LF) dues (on self-assessment basis) for Q2 of FY 2023-24 and has thus breached the provisions of the License Agreement. The details of AGR, LF paid and LF due of M/s VIL for Q2 of FY 2023-24 on self-assessment basis (as per SARAS) is as follows:

Summary of License Fee Dues for Quarter2 of FY 2023-24 in respect of M/s Vodafone Idea Limited on self-assessment basis							
Sl.No.	FY	Quarter	AGR (in Rs.)	LF Due (in Rs.)	LF Paid (in Rs.)	Date of payment	Principal Due
1	2023-24	Q2	96,26,54,23,947	7,70,12,33,916	77,06,33,281	13.10.2023	
					18,19,28,268	29.12.2023	
Total (in Rupees)					95,25,61,549	--	6,74,86,72,367
Total (in Crores)					95.25		674.86

4 . In view of the above, you are hereby directed to pay the outstanding License Fee dues for Quarter-2 of FY 2023-24 (based on the self-assessment of the company) along with applicable interest, immediately. Further, it is intimated that in case of failure of payments by M/s VIL, the necessary steps including invocation of Clause 21.5 of the UL License agreement and other relevant clauses shall be taken up by the DoT as per terms and conditions of license agreement.

This issues with the approval of competent authority.

**Signed by Maddipatla
Prasanna Kumari
Date: 25-01-2024 10:42:14**

Director (LFA-I)

Copy to:

1. PS to Member (F), Digital Communications Commission, DoT HQ, New Delhi.
2. Controller General of Communication Accounts (CGCA), Ghitorni, New Delhi.

3. PS to Advisor (F), DoT HQ, New Delhi.
4. Jt.CGCA (Revenue), O/o CGCA, New Delhi.
5. DDG (LFA/LFP/WPF), DoT Hq, New Delhi.

File No:1012/02/2023-WR
Government of India
Ministry of Communications
Department of Telecommunications
(Wireless Planning Finance Division – WR Section)

Dated: xx.01.2024

To
Vodafone Idea Limited,
7th Floor, Konnectus Tower-3,
Bhavbhuti Marg, New Delhi – 110002

Sub: Adjustment of Rs.755.52 crores pursuant to Hon'ble TDSAT order dated 15.12.2023 in MA No.114/2023 in TP 30 of 2019 – Reg.– Reg., Ref : VIL/RCA/January/2024/0112-003 dated 12.01.2024 & VIL/RCA/January/2024/0115-001 dated 15.01.2024

Please refer to the letter cited above.

2. In accordance with the TDSAT order dated December 15, 2023, a total amount of Rs.755.52 crores has been adjusted by DoT. The adjustment was executed in two phases:

a. Recoverable SUC Dues (FY 2019-20 to 2021-22):

The initial adjustment targeted long-pending recoverable Spectrum Usage Charges (SUC) dues. This pertains to the period from FY 2019-20 to 2021-22. Notably, these dues were not subject to any subjudice matter or covered under any moratorium as of the adjustment date.

b. SUC Dues of Q2 FY 2023-24:

Following the adjustment against past dues, the remaining balance was allocated towards the Spectrum Usage Charges (SUC) dues for Q2 of FY 2023-24.

3. This step ensures compliance with the TDSAT order and further contributes to resolving financial obligations within the specified time frame.

4. It is further intimated that M/s VIL's LF & SUC payments on self assessment basis with respect to Q2 & Q3 of FY 2023-24 have become overdue. Necessary action may be taken as per the license agreement.

This issues with the approval of Competent Authority.

Signed by Tanvika Singh
 (Tanvika Singh)
 Date: 02.02.2024 12:44:27
 Director (WR)

Ph:011-23036821

Copy to:

1. DDG (AS), AS Wing, DoT, Sanchar Bhawan, New Delhi for information.
2. Sr. DDG (LFA), DoT, Sanchar Bhawan, New Delhi for information.
3. CGCA, NICF Campus, Ghitorni, New Delhi for kind information and circulating the same to Assessing Authorities.

**TELECOM DISPUTES SETTLEMENT & APPELLATE TRIBUNAL
NEW DELHI**

Dated: 07/02/2024

TELECOM PETITION/30/2019

WITH
MISC APPLICATION/150/2019

WITH
MISC APPLICATION/114/2023

WITH
MISC APPLICATION/115/2023

WITH
MISC APPLICATION/19/2024

WITH
MISC APPLICATION/20/2024

Petitioner Name: Vodafone Idea Ltd.gj

Versus

Respondent Name: Union Of India

BEFORE

**HON'BLE MR. JUSTICE DHIRUBHAI NARANBHAI PATEL, CHAIRPERSON
HON'BLE MR. SUBODH KUMAR GUPTA ,MEMBER**

**For Applicants/Appellants/
Petitioners Advocate**

Mr. Meet Malhotra, Sr Adv
Mr. Manjul Bajpai
Mr. Pradeep Shukla
Mr. Ravi S.s Chauhan
Ms. Pallak Singh

For Respondents Advocate

Mr. Abhay Prakash Sahay
Mr Sudhanshu Prakash

Amicus Curiae:

For Impleader(Pet.):

For Impleader(Res.):

ORDER

1. **M.A No.19/2024** – This Miscellaneous Application has been preferred by the original petitioner along with additional documents-cum-consolidated convenience compilation.

2. We have heard counsel for the petitioner at length, who has submitted that during the pendency of this Telecom Petition in a different Miscellaneous Application orders have been passed by this Tribunal and effect of those orders have not been granted by the respondent and, therefore, the present M.A has been preferred for an effective implementation of the order of this Tribunal dated 15.12.2023 in M.A No.114/2023 in the present Telecom Petition.

3. Counsel appearing for the petitioner has also taken this Tribunal to Annexure 'J' and Annexure 'O' Which are dated 25.1.2024 and dated 2.2.2024 respectively, which

are the show cause notices, demand and adjustment of Rs.755.52 Crore.

4. Counsel appearing for Union of India is seeking time. Time, as prayed for, is granted to the Union of India, meanwhile, the show cause notice dated 25.1.2024 which are at Annexure 'J' and communication dated 2.2.2024 which is at Annexure 'O' shall not be implemented till next date of hearing.

5. The matter is, therefore, adjourned to 10.4.2024.

**(JUSTICE D. N. PATEL)
CHAIRPERSON**

**(SUBODH KUMAR GUPTA)
MEMBER**

TDSAT order in TP-30/2019 - Instructions for Status Quo to be maintained - Reg.,

From : Tanvika Singh <singh.tanvika@gov.in> Thu, Feb 08, 2024 06:12 PM
Subject : TDSAT order in TP-30/2019 - Instructions for Status Quo to be maintained - Reg., 4 attachments
To : Pratima Singh <dycgcarev-dot@gov.in>, Christeena Joy <assttcgcarev-dot@gov.in>
Cc : Ms. Anuradha Joshi Durgapal <cgca-dot@gov.in>, SRIKANTA PANDA <addcgca-dot@gov.in>, Ashish Joshi <ashish.joshi@nic.in>, Shivendu Gupta <shivendu.gupta@gov.in>, HITHENDRA CHARY <wpf.wr-dot@gov.in>

Sir/Madam,

Please find enclosed herewith the interim order of TDSAT dated 07.02.2024 in TP No.30/2019 and the directions are reproduced hereunder:

"4..... the show cause notice dated 25.1.2024 which are at Annexure 'J' and communication dated 2.2.2024 which is at Annexure 'O' shall not be implemented till next date of hearing".

Also find enclosed herewith the letters dated 25.01.2024 & 02.02.2024 for ready reference.

Accordingly, Assessing Authorities may be instructed, not to issue any show cause notice for non-payment of SUC dues of Q2 & Q3 for FY 2023-24.

Further, the assessing authorities may be requested to maintain status-quo on the instructions issued vide Lr. No.AS-13/5/2019-Office of DIR(AS-V)-Part(1), dated 02.01.2024 (copy enclosed), until further orders.

Regards,

**Tanvika Singh,
Director (WR)
WPF Wing, DoT HQ
New Delhi-110 001**



 **TDSAT order-07.02.2024.pdf**
120 KB

 **Reply to VIL on 755 crores adjustment-02.02.2024.pdf**
90 KB

 **Adjustment of 755.52 crores-letter to CGCA-02.01.2024.pdf**
967 KB

 **LFA letter-25.01.2024.pdf**
73 KB

**TELECOM DISPUTES SETTLEMENT & APPELLATE TRIBUNAL
NEW DELHI**

Dated: 07/02/2024

TELECOM PETITION/30/2019

WITH

MISC APPLICATION/150/2019

WITH

MISC APPLICATION/114/2023

WITH

MISC APPLICATION/115/2023

WITH

MISC APPLICATION/19/2024

WITH

MISC APPLICATION/20/2024

Petitioner Name: Vodafone Idea Ltd.gj

Versus

Respondent Name: Union Of India

BEFORE

**HON'BLE MR. JUSTICE DHIRUBHAI NARANBHAI PATEL, CHAIRPERSON
HON'BLE MR. SUBODH KUMAR GUPTA ,MEMBER**

**For Applicants/Appellants/
Petitioners Advocate**

Mr. Meet Malhotra, Sr Adv
Mr. Manjul Bajpai
Mr. Pradeep Shukla
Mr. Ravi S.s Chauhan
Ms. Pallak Singh

For Respondents Advocate

Mr. Abhay Prakash Sahay
Mr Sudhanshu Prakash

Amicus Curiae:

For Impleader(Pet.):

For Impleader(Res.):

ORDER

1. **M.A No.19/2024** – This Miscellaneous Application has been preferred by the original petitioner along with additional documents-cum-consolidated convenience compilation.
2. We have heard counsel for the petitioner at length, who has submitted that during the pendency of this Telecom Petition in a different Miscellaneous Application orders have been passed by this Tribunal and effect of those orders have not been granted by the respondent and, therefore, the present M.A has been preferred for an effective implementation of the order of this Tribunal dated 15.12.2023 in M.A No.114/2023 in the present Telecom Petition.
3. Counsel appearing for the petitioner has also taken this Tribunal to Annexure 'J' and Annexure 'O' Which are dated 25.1.2024 and dated 2.2.2024 respectively, which

are the show cause notices, demand and adjustment of Rs.755.52 Crore.

4. Counsel appearing for Union of India is seeking time. Time, as prayed for, is granted to the Union of India, meanwhile, the show cause notice dated 25.1.2024 which are at Annexure 'J' and communication dated 2.2.2024 which is at Annexure 'O' shall not be implemented till next date of hearing.

5. The matter is, therefore, adjourned to 10.4.2024.

(JUSTICE D. N. PATEL)
CHAIRPERSON

(SUBODH KUMAR GUPTA)
MEMBER

File No:1012/02/2023-WR
Government of India
Ministry of Communications
Department of Telecommunications
(Wireless Planning Finance Division – WR Section)

Dated: xx.01.2024

To
Vodafone Idea Limited,
7th Floor, Konnectus Tower-3,
Bhavbhuti Marg, New Delhi – 110002

Sub: Adjustment of Rs.755.52 crores pursuant to Hon'ble TDSAT order dated 15.12.2023 in MA No.114/2023 in TP 30 of 2019 – Reg.– Reg., Ref : VIL/RCA/January/2024/0112-003 dated 12.01.2024 & VIL/RCA/January/2024/0115-001 dated 15.01.2024

Please refer to the letter cited above.

2. In accordance with the TDSAT order dated December 15, 2023, a total amount of Rs.755.52 crores has been adjusted by DoT. The adjustment was executed in two phases:

a. Recoverable SUC Dues (FY 2019-20 to 2021-22):

The initial adjustment targeted long-pending recoverable Spectrum Usage Charges (SUC) dues. This pertains to the period from FY 2019-20 to 2021-22. Notably, these dues were not subject to any subjudice matter or covered under any moratorium as of the adjustment date.

b. SUC Dues of Q2 FY 2023-24:

Following the adjustment against past dues, the remaining balance was allocated towards the Spectrum Usage Charges (SUC) dues for Q2 of FY 2023-24.

3. This step ensures compliance with the TDSAT order and further contributes to resolving financial obligations within the specified time frame.

4. It is further intimated that M/s VIL's LF & SUC payments on self assessment basis with respect to Q2 & Q3 of FY 2023-24 have become overdue. Necessary action may be taken as per the license agreement.

This issues with the approval of Competent Authority.

Signed by Tanvika Singh
(Tanvika Singh)
Date: 02-02-2024 12:44:27
Director (WR)
Ph:011-23036821

Copy to:

1. DDG (AS), AS Wing, DoT, Sanchar Bhawan, New Delhi for information.
2. Sr. DDG (LFA), DoT, Sanchar Bhawan, New Delhi for information.
3. CGCA, NICF Campus, Ghitorni, New Delhi for kind information and circulating the same to Assessing Authorities.



File No: AS-13/5/2019-Office of DIR(AS-V)-Part(1)
Government of India
Ministry of Communications
Department of Telecommunications
(Wireless Planning Finance Division – WR Section)

To
The CGCA,
NICF Campus,
Ghitorni, New Delhi – 110047

Dated: 02.01.2024

Sub: Adjustment of Rs.755.52 crores pursuant to Hon'ble TDSAT order dated 15.12.2023 in MA No.114/2023 in TP 30 of 2019 – Reg.,

As part of interim order in TP-30/2019, Hon'ble Tribunal has instructed the Department to adjust the amount of Rs.755.52 crores against LF and SUC dues of M/s VIL within a timeline of 15 days.

2. Your office had communicated details of CCA/Year wise outstanding SUC dues with interest up to OCT-2023 to WPF Wing vide email dated 22.12.2023. Based on this information, Rs.755.52 crore have been centrally taken as receipt against outstanding SUC dues of M/s.VIL for FY 2019-20 to 2021-22 and towards SUC liability for Q2 of 2023-24 in 6 circles at PAO, DoT HQ (Circle wise & year wise details are as per Annexure).

3. It is requested to inform Assessing Authorities of this adjustment done at DOT HQ centrally so that they may accordingly revise the outstanding SUC dues payable by M/s.VIL. Date of credit may be taken as 15.12.2023 for calculation of interest & balance outstanding dues.

4. The revised outstanding SUC dues of M/s.VIL with interest updated upto 31.12.2023 may be intimated to this office in Proforma – I by 10.01.2024.

This issues with the approval of the competent authority.

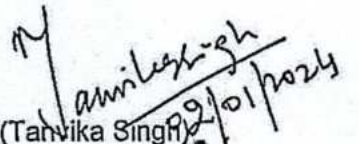
(Tanvika Singh)
Director (WR)
Ph:011-23036821

Copy to:

1. DDG (AS), AS Wing, DoT, Sanchar Bhawan, New Delhi for information.

Annexure

CCA wise details of the amount to be adjusted towards SUC Outstanding dues of M/s. Vodafone Idea Limited

CCA	Amount to be adjusted against 2019-20 dues			Amount to be adjusted against 2020-21 dues			Amount to be adjusted against 22 dues			Amount to be adjusted for Q2 of 2023-24		
	GSM	M/WA	MWB	GSM	M/WA	MWB	GSM	M/WA	MWB	GSM	M/WA	MWB
Andhra Pradesh	71039987	0	0	0	0	0	0	0	0	0	0	0
Assam	87106271	19170463	7760988	104117407	0	0	0	0	0	0	0	0
Bihar	136040283	10561630	4111867	59796364	398118	143868	27264186	0	0	0	0	0
Delhi	184509395	0	0	0	54117578	0	0	0	0	0	0	0
Gujarat	116018728	0	0	4783646	2604042	314888	1102293	2409169	0	0	0	0
Haryana	30407036	1815505	0	0	13909602	0	57415703	11992964	0	0	0	0
Himachal Pradesh	4945926	1531130	468447	47475	11237	2106	56017	14297	2532	0	0	0
Jammu & Kashmir	5873053	1892832	634099	636910	0	0	1512017	84685	23096	0	0	0
Karnataka	440370793	4500610	1483691	82594270	0	0	170069594	21952089	4038498	31593321	68142456	9292158
Kerala	121571584	17012133	6097211	0	1671786	227968	468873	0	0	0	0	0
Kolkata	0	0	0	0	0	0	0	0	0	0	0	0
Madhya Pradesh	0	0	0	0	0	0	0	0	0	0	0	0
Maharashtra	118469145	104689380	0	3179657	0	0	3438086	0	0	68025582	92380419	0
Mumbai	71834185	11102109	0	0	0	0	0	0	0	46667142	48428163	0
North East	15304984	97160	18217	0	0	0	0	2976392	558074	0	0	0
Orissa	35241375	0	0	0	0	0	0	0	0	0	0	0
Punjab	117342079	67910127	0	50403966	563174	0	116485204	43425887	0	0	0	0
Rajasthan	36132715	58428550	1188202	0	0	0	2652639	620509	114745	13653051	22051935	0
Tamilnadu	1588970899	50521839	0	1103004749	0	0	325467595	5962649	608507	33171579	87452334	9046791
Uttar Pradesh (E)	209478860	12244196	5128363	55080492	0	0	13758914	0	0	0	0	0
Uttar Pradesh (W)	280003457	10103552	2087369	69131348	0	0	120163196	19964430	0	0	0	0
West Bengal	234413623	0	0	34876633	0	0	35248659	32209850	5962696	11308148	248626644	18338949
Total	3905074378	371581216	28978454	1473652917	73275537	688830	875102976	141612921	11308148	248626644	406959030	18338949
Total in Crores												

Amuldeep Singh
20/1/2024

**Government of India
Ministry of Communications
Department of Telecommunications
(Licensing Finance Assessment Wing)
Sanchar Bhawan, 20 Ashoka Road, New Delhi -110001**

Show Cause Notice

No.1-14/2024/LFA/VIL

Dated:25.01.2024

To

M/s Vodafone Idea Limited,
7th Floor, Konnectus Tower 3, Bhavbhuti Marg,
Opp. New Delhi Railway Station (Ajmeri Gate Side),
New Delhi – 110001.
Ph: 011 23210134.

Subject: Show Cause Notice for short payment of Quarterly License Fee dues for Quarter-2 of FY 2023-24 on self-assessment basis in respect of M/s Vodafone Idea Limited.

Ref: (i) Representations dated 18.12.2023 & 28.12.2023 received from your respective office.

(ii) DoT's letter No.AS-13/5/2019-Office of DIR (AS-V)-Part (1) dated 27.12.2023

This is regarding short payment of quarterly License Fee dues for Q2 of FY 2023-24 in respect of M/s Vodafone Idea Limited as per license agreement.

2. The payment terms are governed by Clause 20.4 of Unified License Agreement and equivalent clauses of other license agreements. Vide Clause 20.4 of UL agreement, it is stated that –

*"License Fee shall be payable in four quarterly installments during each financial year (FY). Quarterly installment of license fee for the first three quarters of a financial year shall be paid **within 15 days of the completion of the relevant quarter**. The AGR based license Fee shall be paid by the Licensee on the basis of revenue on accrual basis for the quarter, duly certified with an affidavit by a representative of the Licensee who is authorized by the Board*

Resolution coupled with General Power of Attorney. However, for the last quarter of the financial year, the Licensee shall pay the License Fee by 25th March on the basis of expected revenue for the quarter, subject to a minimum payment equal to the revenue share paid for the previous quarter."

3. M/s VIL has made short payment of the quarterly License Fee (LF) dues (on self-assessment basis) for Q2 of FY 2023-24 and has thus breached the provisions of the License Agreement. The details of AGR, LF paid and LF due of M/s VIL for Q2 of FY 2023-24 on self-assessment basis (as per SARAS) is as follows:

Summary of License Fee Dues for Quarter2 of FY 2023-24 in respect of M/s Vodafone Idea Limited on self-assessment basis							
Sl.No.	FY	Quarter	AGR (in Rs.)	LF Due (in Rs.)	LF Paid (in Rs.)	Date of payment	Principal Due
1	2023-24	Q2	96,26,54,23,947	7,70,12,33,916	77,06,33,281	13.10.2023	
					18,19,28,268	29.12.2023	
Total (in Rupees)					95,25,61,549	--	6,74,86,72,367
Total (in Crores)					95.25		674.86

4. In view of the above, you are hereby directed to pay the outstanding License Fee dues for Quarter-2 of FY 2023-24 (based on the self-assessment of the company) along with applicable interest, immediately. Further, it is intimated that in case of failure of payments by M/s VIL, the necessary steps including invocation of Clause 21.5 of the UL License agreement and other relevant clauses shall be taken up by the DoT as per terms and conditions of license agreement.

This issues with the approval of competent authority.

**Signed by Maddipatla
Prasanna Kumari
Date: 25-01-2024 10:42:14**

Director (LFA-I)

Copy to:

1. PS to Member (F), Digital Communications Commission, DoT HQ, New Delhi.
2. Controller General of Communication Accounts (CGCA), Ghitorni, New Delhi.

3. PS to Advisor (F), DoT HQ, New Delhi.
4. Jt.CGCA (Revenue), O/o CGCA, New Delhi.
5. DDG (LFA/LFP/WPF), DoT Hq, New Delhi.

Fwd: BSNL SUC assessment – Reg.,

From : Christeena Joy <assttcgcarev-dot@gov.in>

Thu, Feb 08, 2024 06:39 PM

Subject : Fwd: BSNL SUC assessment – Reg.,

2 attachments

To : G Venkata Bhavani <aolf.ccaap-dot@gov.in>, CCA, AP <cca-ap@nic.in>, dbacca-ap@nic.in, CCA Bihar <cca-bih@nic.in>, CCA CHHATISGARH <cca.cg-dot@nic.in>, ccadelhi@gmail.com, CCA Gujarat <cca.guj-dot@nic.in>, Ranganath Shyam <ccatrivandrum@nic.in>, pccakolkata@gmail.com, HARI GOVIND SINGH DHAKAD <cca.mp-dot@nic.in>, cca mhgoa <cca.mhgoa@gmail.com>, ccamumbai@gmail.com, ccalfhyd@gmail.com, Sangeet Kumar <cca.upeast@gov.in>, ccaupwest@gmail.com, CCA Dehradun <ccaddn-dot@nic.in>, CCA WB <ccaawbc-dot@nic.in>, ccadehradun@rediffmail.com, caolfccaupe@gmail.com, revenue ccadelhi <revenue.ccadelhi@gmail.com>, AO LF <ao-licensefee@ccakolkata.gov.in>, jtccauk@gmail.com, BB Joshi <jtcca.ddn-dot@gov.in>, cca revenue-rj <cca.revenue-rj@gov.in>, lfsectionccabihar@gmail.com, ccahariyana@gmail.com, MAYANK NEGI <cca-telecom-hp@nic.in>, CCA J&K Circle <cca.jk@nic.in>, Dipankar Mahto <cca.jh-dot@nic.in>, Geethanjali H.C <aolf.ccakar-dot@gov.in>, ccanortheast@gmail.com, ccane2dimapur@gmail.com, CCA ODISHA <ccaodisha.dot@nic.in>, CCA Punjab <cca.pb-dot@nic.in>, CCA Rajasthan <cca-jaip-rj-dot@nic.in>, CCA Tamilnadu <ccatn.tn@nic.in>, CCA Assam <ccaassam@nic.in>, Kailash Chandra <kailash.tunial@gov.in>, ccaassam@gmail.com, CCA-HR-REV <aorevcca.amb-dot@gov.in>, Chetram Meena <dyccalfdot-mp@nic.in>, Deputy Controller of Communication Account s <dyccalfuso.ccatn@nic.in>

Cc : Ashish Joshi <jtcgcarev-dot@gov.in>, Pratima Singh <dycgcarev-dot@gov.in>, G Sessa <gssn.bharadwaj@gov.in>, Rupa Boddu <rupa.boddu@gov.in>

Respected Sir/Madam,

Please find the trailing mail received from WR Section and please find enclosed herewith the WPC orders relating to regularization/re-assignment/fresh assignment of Spectrum to BSNL in 900 MHz & 1800 MHz bands in various LSAs:

- i. Lr. No.L-14041/01/2020-NTG, dated 27.10.2022 wherein re-assignment/fresh assignment of frequencies to BSNL in 900 MHz band (circulated vide this office email dt.02.11.2022 and 14.12.2022).
- ii. Lr. No.L-14041/01/2020-NTG, dated 15.01.2024 wherein regularization of the spectrum of BSNL post the expiry of service license (circulated vide this office email dt.17.01.2024)

In this regard,

It is requested to to check whether this spectrum assignment is considered in the final SUC assessment for the FY 2019-20 to 2021-22.

1. If yes please revert back to this email
2. In case of revision of SUC dues, the details of the revised dues may be submitted to this office, for onward submission to DoT on or before 23.02.2024

With regards

Christeena Joy
Asstt.CGCA (Revenue)
O/o CGCA, NICF Campus
Ghitorni
New Delhi 110047

Government of India
Ministry of Communications
Department of Telecommunications
Wireless Planning and Coordination Wing

6th floor, Sanchar Bhawan,
20, Ashoka Road, New Delhi - 110 001.

No.: L-14041/01/2020-NTG

Date: 27.10.2022

To,
M/s Bharat Sanchar Nigam Limited
Regulation Cell, Corporate Office
3rd Floor, Bharat Sanchar Bhavan
Harish Chandra Mathur Lane
Janpath, New Delhi - 110001

Subject: Re-assignment/Fresh assignment of frequencies to BSNL in the 900 MHz band in view of the Cabinet decision on 27.07.2022

Reference: (ii) BSNL CO-RGLN/28/5/2020-REGLN/E-5320 dated 30.08.2022

Sir,

As per the decision of the Union Cabinet in the meeting held on 27.07.2022, the frequency spots assigned to you, consequent to harmonization exercise carried out in certain LSAs, along with the Effective date of assignment and Date of expiry are as per details mentioned in Annexure-I. Technical parameters are attached at Annexure-II. The provisions w.r.t charging SUC is placed at Annexure - III.

2. The frequency assignment, contained in Annexure-I, is subject to the following:
- (i). There shall be no change in the frequency assignment or any technical parameters associated therewith, as detailed in Annexure-I, without the prior written approval of Wireless Planning and Coordination (WPC) Wing, Department of Telecommunications, Ministry of Communications.
 - (ii). The Government reserves the right to change the frequency spots and technical parameters at any point of time over the duration of its validity period of 20 years, whenever it is required for harmonizing bands and promoting spectrum efficiency.
 - (iii). The individual carriers can be combined, provided they are not administratively assigned, to make use of new technology requiring larger bandwidth. Technology other than GSM/CDMA/WCDMA/LTE/IMT-2020 (5G technology), employed in each band in each LSA, shall be intimated to WPC Wing, wherein prior approval is required.
 - (iv). The Base Stations along the borders are to be registered with ITU, through WPC Wing, in order to effect co-ordination in the case of cross-border interference.
 - (v). The Base Stations near international border shall be so located and operated that the radio signals emanating therefrom, fade out at the international border to an extent to become unusable at the international border, but this condition may be relaxed with the agreement of the administration concerned.

- (vi). The new Base Stations or changes to the existing Base Stations to employ the frequencies assigned herein shall not cause harmful interference to a station operating in accordance with the technical parameters authorised by WPC Wing.
- (vii). Limits/levels on EMF exposure by Base Stations should be restricted to the limits as prescribed by the Department of Telecommunications from time to time.
- (viii). An officer authorised by WPC Wing may inspect the wireless stations to verify that the said stations operate as per technical parameters assigned.
- (ix). The SACFA clearance for all the Base Stations shall be obtained from WPC Wing as per the extant procedure.
- (x). The wireless equipment to be employed shall be imported, if required, as per the extant procedure.
- (xi). The frequency assignment shall be revoked or temporarily suspended, as the case may be, for violation of unauthorised use of frequencies and technical parameters associated therewith, breach of the conditions stipulated in the service license (UASL/ UL) or non-payment of fees/charges associated with the spectrum.
- (xii). The continuation of frequency assignment is subject to fulfilment of all payment terms and adherence to conditions stipulated in the relevant service licenses (UASL/UL).
- (xiii). The above terms and conditions are without prejudice to any other action that may be taken by the Government.
3. The terms and conditions governing frequency spots assigned earlier, if any, would be as per the respective frequency assignment letters. Changeover of frequency spots, if any, shall be done at the earliest not later than 2 weeks' time from the date of issue of this letter.

Vineeth
27.10.22

(Vineeth Kurian Mathew)
Assistant Wireless Advisor to the Govt. of India

Encl: Annexure I, II & III

(विनीत कुरियन माथेय)
(VINEETH KURIAN MATHEW)
सहायक बेतार सलाहकार
Assistant Wireless Advisor
दूरसंचार विभाग, भारत सरकार
Deptt. of Telecom, Govt. of India
नई दिल्ली / New Delhi

Copy to:

1. DDG(WPF) with a request to intimate the office of CGCA and CCA offices to consider the frequency allocation to BSNL in their SUC assessments.
2. DDG(PM) for information.
3. Director(WMO) for information.

Frequency carriers assigned to M/s BSNL									
Service Area	No. of blocks	Assigned Carrier Frequencies (in MHz)				BW	Effective Date	Date of Expiry	Remarks
		900 MHz band (FDD)							
		Uplink		Downlink					
		Start	Stop	Start	Stop				
Andhra Pradesh	28	908.5	914.1	953.5	959.1	5.6	29.02.2020	28.02.2040	
Andhra Pradesh	4	914.1	914.9	959.1	959.9	0.8	27.10.2022	26.10.2042	
Assam	25	908.5	913.5	953.5	958.5	5.0	29.02.2020	28.02.2040	
Assam	7	913.5	914.9	958.5	959.9	1.4	27.10.2022	26.10.2042	
Bihar	25	906.9	911.9	951.9	956.9	5.0	29.02.2020	28.02.2040	
Bihar	7	911.9	913.3	956.9	958.3	1.4	27.10.2022	26.10.2042	
Gujarat	25	908.5	913.5	953.5	958.5	5.0	29.02.2020	28.02.2040	
Gujarat	7	913.5	914.9	958.5	959.9	1.4	27.10.2022	26.10.2042	
Haryana	28	908.5	914.1	953.5	959.1	5.6	29.02.2020	28.02.2040	
Haryana	4	914.1	914.9	959.1	959.9	0.8	27.10.2022	26.10.2042	
Himachal Pradesh	28	908.5	914.1	953.5	959.1	5.6	29.02.2020	28.02.2040	
Himachal Pradesh	4	914.1	914.9	959.1	959.9	0.8	27.10.2022	26.10.2042	
Jammu & Kashmir	25	908.5	913.5	953.5	958.5	5.0	29.02.2020	28.02.2040	
Jammu & Kashmir	7	913.5	914.9	958.5	959.9	1.4	27.10.2022	26.10.2042	
Karnataka	28	908.5	914.1	953.5	959.1	5.6	29.02.2020	28.02.2040	
Karnataka	4	914.1	914.9	959.1	959.9	0.8	27.10.2022	26.10.2042	
Kerala	31	908.5	914.7	953.5	959.7	6.2	29.02.2020	28.02.2040	
Kerala	1	914.7	914.9	959.7	959.9	0.2	27.10.2022	26.10.2042	
Kolkata	25	906.9	911.9	951.9	956.9	5.0	29.02.2020	28.02.2040	
Kolkata	7	911.9	913.3	956.9	958.3	1.4	27.10.2022	26.10.2042	
Madhya Pradesh	25	906.9	911.9	951.9	956.9	5.0	29.02.2020	28.02.2040	
Madhya Pradesh	7	911.9	913.3	956.9	958.3	1.4	27.10.2022	26.10.2042	
Maharashtra	25	906.9	911.9	951.9	956.9	5.0	29.02.2020	28.02.2040	
Maharashtra	7	911.9	913.3	956.9	958.3	1.4	27.10.2022	26.10.2042	
North East	25	908.5	913.5	953.5	958.5	5.0	29.02.2020	28.02.2040	
North East	7	913.5	914.9	958.5	959.9	1.4	27.10.2022	26.10.2042	
Odisha	28	908.5	914.1	953.5	959.1	5.6	29.02.2020	28.02.2040	
Odisha	4	914.1	914.9	959.1	959.9	0.8	27.10.2022	26.10.2042	
Punjab	25	908.5	913.5	953.5	958.5	5.0	29.02.2020	28.02.2040	
Punjab	7	913.5	914.9	958.5	959.9	1.4	27.10.2022	26.10.2042	
Rajasthan	28	908.5	914.1	953.5	959.1	5.6	29.02.2020	28.02.2040	
Rajasthan	4	914.1	914.9	959.1	959.9	0.8	27.10.2022	26.10.2042	
Tamil Nadu	28	908.5	914.1	953.5	959.1	5.6	29.02.2020	28.02.2040	
Tamil Nadu	4	914.1	914.9	959.1	959.9	0.8	27.10.2022	26.10.2042	
Uttar Pradesh (East)	25	906.9	911.9	951.9	956.9	5.0	29.02.2020	28.02.2040	
Uttar Pradesh (East)	7	911.9	913.3	956.9	958.3	1.4	27.10.2022	26.10.2042	
Uttar Pradesh (West)	25	908.5	913.5	953.5	958.5	5.0	29.02.2020	28.02.2040	
Uttar Pradesh (West)	7	913.5	914.9	958.5	959.9	1.4	27.10.2022	26.10.2042	
West Bengal	28	906.9	912.5	951.9	957.5	5.6	29.02.2020	28.02.2040	
West Bengal	4	912.5	913.3	957.5	958.3	0.8	27.10.2022	26.10.2042	

Vinith
27.10.22

Technical Parameters

Technical parameters associated with the frequencies listed in Annexure-I including other common particulars are as given below:

(i).	Licensed Service Area	900 MHz: Andhra Pradesh, Assam, Bihar, Gujarat, Haryana, Himachal Pradesh, Jammu & Kashmir, Karnataka, Kerala, Kolkata, Madhya Pradesh, Maharashtra, North East, Odisha, Punjab, Rajasthan, Tamil Nadu, Uttar Pradesh (East), Uttar Pradesh (West), West Bengal
(ii).	Period of validity	20 years (from the effective date as mentioned in Annexure-I)
(iii).	Base Station Power (Max)	2G technology: 20 W 3G/4G technology: As per DoT Office Memorandum No. L-14010/03/2014-NTG dated 19.06.2018. IMT-2020 (5G technology): (i). The permitted maximum RF output power/EIRP of the base station in all the frequency bands and out of band emission limits must be in compliance to the international standards of 3GPP/ITU/TEC etc. and/or international practices adopted by bodies such as CEPT/OFCOM/FCC etc, subject to meeting the EMF limits prescribed by the Department of Telecommunications from time to time.
(iv).	Mobile Station Power (Max)	As per TEC/ International standards
(v).	Emission (as applicable)	200KG7W, 200KQ7W, 1M40G7W, 3M00G7W, 5M00G7W
(vi).	Exclusion zones	There shall be an exclusion zone of 30 km around GMRT in Pune (19 05 26.31 N, 74 02 59.65 E) in the 900 MHz band in the Maharashtra LSA.

Vinay
27.10.22

The provisions w.r.t charging Spectrum Usage Charges

1. For the quantum of spectrum expired on 28.02.2020 and re-assigned w.e.f from 29.02.2020:
 - a. For the period from 29.02.2020 to 20.06.2022, SUC rate of 3% shall be applied in calculation of overall weighted average SUC rate to be applied on (Adjusted Gross Revenue) AGR, excluding the revenue from wireline services.
 - b. For the period from 21.06.2022 till expiry of spectrum, SUC rate of 0% shall be applied in calculation of weighted average SUC rate to be applied on (Adjusted Gross Revenue) AGR, excluding the revenue from wireline services. (on similar lines of spectrum allocated through auctions held after 15.09.2022 as per DoT Order No. L-14010/ 01/2021-NTG dated 21.06.2022).
2. For the additional quantum of spectrum, now being allotted with prospective effect, SUC rate of 0% shall be applied in calculating overall weighted average SUC rate to be applied on (Adjusted Gross Revenue) AGR , excluding the revenue from wireline services. (on similar lines of spectrum allocated through auctions held after 15.09.2022 as per DoT Order No. L-14010/01/2021-NTG dated 21.06.2022)

Vinh
27.10.22

**Government of India
Ministry of Communications
Department of Telecommunications
Wireless Planning & Coordination (WPC) Wing
Sanchar Bhawan, 20, Ashoka Road, New Delhi – 110001-**

No. L-14010/02/2024-IMT

Date: 09-02-2024

OFFICE MEMORANDUM

Subject: Provisional assignment/extension of the spectrum rights which is expiring in the year 2024, before the conclusion of next spectrum auction (Auction 23-24) to avoid disruption of public services.

The competent authority has decided that operating TSPs (excluding those in Corporate Insolvency Resolution Process) whose spectrum is going to expire in the year 2024, before the conclusion of next spectrum auction (Auction 23-24), shall be permitted to retain such spectrum on prior written request for interim period i.e. for the period from the date of expiry till the completion of Auction 23-24 process, which would include time for assignment and time for migration required when such spectrum is assigned to non-incumbent bidder. The terms and conditions for this extension shall be as follows:

- i. TSPs requesting DoT for retaining such spectrum (Annexure – I) for the interim period shall pay spectrum charges for this period that will be equal to the pro-rated amount based on the Auction Determined Price of Auction 23-24. Till the Auction Price is determined in the Auction 23-24, the provisional price as per Annexure -I, shall be used.
- ii. TSPs opting for spectrum continuation, shall pay in advance, as per the above provisional price, for a 3 - months period.
- iii. If Auction 23-24 does not conclude within this initial 3 - months period, subsequent extensions for every 3 months shall be allowed, each requiring advance payment as envisaged in (ii) above.
- iv. After the conclusion of the Auction 23-24, any excess in spectrum charges paid by TSPs for the duration of extension, will be adjusted in the first instalment/upfront payment, without interest. In case of shortfall, additional demand shall be payable. In event of failure to pay such demand, such amount shall be recovered from any bank guarantee available with DoT.
- v. For this interim period, all Terms and Conditions of Auction 22-23, as per NIA 2022 dated 15-06-2022, shall be applicable on the TSP.
- vi. In event of incumbent TSP not winning such spectrum in Auction 23-24, a maximum transition period up to two months shall be allowed to the incumbent TSP from date of declaration of the provisional result of Auction 23-24.

- vii. Further, for the spectrum which is expiring in the year 2024 and whose assignment is extended through this interim arrangement, Effective Date for such spectrum, when acquired by the same licensee who is holding the spectrum, in Auction 23-24, will be the day following the expiry date of the earlier assignment (i.e. day following the expiry date mentioned in Annexure-I).
2. The application for extension of expiry by a TSP shall include the details such as the LSA, band, quantum of spectrum required (limited to the existing administrative holding that is expiring in 2024), along with other technical parameters.
3. On acceptance of the above terms and conditions, the same shall become part of the existing license agreement.

Encl: as above

Vineeth
09-02-2024
(Vineeth Mathew)

Assistant Wireless Advisor
to Govt. of India

To,

All concerned.

Annexure - I

Date wise breakup of expiry of administratively assigned spectrum to the TSPs in 2024 with provisional price

Frequency Band	LSA	TSP/Licensee	Quantum of Paired Spectrum held (in MHz)	Date of Expiry	Provisional Price per MHz per 20 years in INR crores
1800 MHz	Bihar	Bharti	1	09-02-2024	82
1800 MHz	Bihar	Bharti	1.8	09-02-2024	82
1800 MHz	Bihar	Bharti	0.2	09-02-2024	82
900 MHz	Bihar	Bharti	6.2	09-02-2024	147
900 MHz	Jammu & Kashmir	Bharti	4.4	09-02-2024	18
900 MHz	Jammu & Kashmir	Bharti	1.8	09-02-2024	18
1800 MHz	Odisha	Bharti	0.6	09-02-2024	39
900 MHz	Odisha	Bharti	6.2	09-02-2024	64
1800 MHz	Uttar Pradesh (East)	Bharti	1	09-02-2024	184
900 MHz	Uttar Pradesh (East)	Bharti	6.2	09-02-2024	186
1800 MHz	West Bengal	Bharti	1.8	10-02-2024	58
900 MHz	West Bengal	Bharti	4.4	10-02-2024	99
900 MHz	Uttar Pradesh (West)	Vodafone Idea	6.2	12-02-2024	152
1800 MHz	West Bengal	Vodafone Idea	1.8	22-03-2024	58
900 MHz	West Bengal	Vodafone Idea	3.6	22-03-2024	99
900 MHz	West Bengal	Vodafone Idea	0.8	22-03-2024	99
1800 MHz	Assam	Bharti	4.4	07-07-2024	32
900 MHz	Assam	Bharti	1.8	07-07-2024	63

Vinay
09-02-24



File No:1012/02/2023-WR
Government of India
Ministry of Communications
Department of Telecommunications
(Wireless Planning Finance Division – WR Section)

To
 The CGCA,
 NICF Campus,
 Ghitorni, New Delhi – 110047

Dated: xx.02.2024

Sub: Communicating the Hon'ble TDSAT order dated 07.02.2022 in TP 30 of 2019 – Reg.,

Please refer this office letter Lr. No.AS-13/5/2019-Office of DIR(AS-V)-Part(1), dated 02.01.2024 (copy enclosed) wherein adjustment of Rs 755.52 cr towards M/s VIL outstanding SUC dues for the years 2019-20 to 2023-24 were communicated in compliance to Hon'ble TDSAT interim order in TP 30/2019. M/s VIL approached Hon'ble TDSAT for adjustment of said amount completely against the Licence Fee/SUC dues payable in Q2 2023-24 on self assessment basis.

Please find enclosed herewith the interim order of TDSAT dated 07.02.2024 in TP No.30/2019 and the directions are reproduced hereunder:

"4..... the show cause notice dated 25.1.2024 which are at Annexure 'J' and communication dated 2.2.2024 which is at Annexure'O' shall not be implemented till next date of hearing".

2. Also find enclosed herewith the letters dated 25.01.2024 & 02.02.2024 for ready reference.
3. Accordingly, Assessing Authorities may be instructed to not issue any show cause notice for non-payment of SUC dues of Q2 & Q3 for FY 2023-24.
4. Further, the Assessing Authorities may be requested to maintain status-quo on the instructions issued vide Lr. No.AS-13/5/2019-Office of DIR(AS-V)-Part(1), dated 02.01.2024, until further directions from this office.

This issues with the approval of the competent authority.

Signed by Tanvika Singh
Date: 10-02-2024 11:40:44
 (Tanvika Singh)
 Director (WR)
 Ph:011-23036821

**TELECOM DISPUTES SETTLEMENT & APPELLATE TRIBUNAL
NEW DELHI**

Dated: 07/02/2024

TELECOM PETITION/30/2019

WITH

MISC APPLICATION/150/2019

WITH

MISC APPLICATION/114/2023

WITH

MISC APPLICATION/115/2023

WITH

MISC APPLICATION/19/2024

WITH

MISC APPLICATION/20/2024

Petitioner Name: Vodafone Idea Ltd.gj

Versus

Respondent Name: Union Of India

BEFORE

HON'BLE MR. JUSTICE DHIRUBHAI NARANBHAI PATEL, CHAIRPERSON

HON'BLE MR. SUBODH KUMAR GUPTA ,MEMBER

**For Applicants/Appellants/
Petitioners Advocate**

Mr. Meet Malhotra, Sr Adv
Mr. Manjul Bajpai
Mr. Pradeep Shukla
Mr. Ravi S.s Chauhan
Ms. Pallak Singh

For Respondents Advocate

Mr. Abhay Prakash Sahay
Mr Sudhanshu Prakash

Amicus Curiae:

For Impleader(Pet.):

For Impleader(Res.):

ORDER

1. **M.A No.19/2024** – This Miscellaneous Application has been preferred by the original petitioner along with additional documents-cum-consolidated convenience compilation.

2. We have heard counsel for the petitioner at length, who has submitted that during the pendency of this Telecom Petition in a different Miscellaneous Application orders have been passed by this Tribunal and effect of those orders have not been granted by the respondent and, therefore, the present M.A has been preferred for an effective implementation of the order of this Tribunal dated 15.12.2023 in M.A No.114/2023 in the present Telecom Petition.

3. Counsel appearing for the petitioner has also taken this Tribunal to Annexure 'J' and Annexure 'O' Which are dated 25.1.2024 and dated 2.2.2024 respectively, which

are the show cause notices, demand and adjustment of Rs.755.52 Crore.

4. Counsel appearing for Union of India is seeking time. Time, as prayed for, is granted to the Union of India, meanwhile, the show cause notice dated 25.1.2024 which are at Annexure 'J' and communication dated 2.2.2024 which is at Annexure 'O' shall not be implemented till next date of hearing.

5. The matter is, therefore, adjourned to 10.4.2024.

**(JUSTICE D. N. PATEL)
CHAIRPERSON**

**(SUBODH KUMAR GUPTA)
MEMBER**

**Government of India
Ministry of Communications
Department of Telecommunications
(Licensing Finance Assessment Wing)
Sanchar Bhawan, 20 Ashoka Road, New Delhi -110001**

Show Cause Notice

No.1-14/2024/LFA/VIL

Dated:25.01.2024

To

M/s Vodafone Idea Limited,
7th Floor, Konnectus Tower 3, Bhavbhuti Marg,
Opp. New Delhi Railway Station (Ajmeri Gate Side),
New Delhi – 110001.
Ph: 011 23210134.

Subject: Show Cause Notice for short payment of Quarterly License Fee dues for Quarter-2 of FY 2023-24 on self-assessment basis in respect of M/s Vodafone Idea Limited.

Ref: (i) Representations dated 18.12.2023 & 28.12.2023 received from your respective office.

(ii) DoT's letter No.AS-13/5/2019-Office of DIR (AS-V)-Part (1) dated 27.12.2023

This is regarding short payment of quarterly License Fee dues for Q2 of FY 2023-24 in respect of M/s Vodafone Idea Limited as per license agreement.

2. The payment terms are governed by Clause 20.4 of Unified License Agreement and equivalent clauses of other license agreements. Vide Clause 20.4 of UL agreement, it is stated that –

*"License Fee shall be payable in four quarterly installments during each financial year (FY). Quarterly installment of license fee for the first three quarters of a financial year shall be paid **within 15 days of the completion of the relevant quarter**. The AGR based license Fee shall be paid by the Licensee on the basis of revenue on accrual basis for the quarter, duly certified with an affidavit by a representative of the Licensee who is authorized by the Board*

Resolution coupled with General Power of Attorney. However, for the last quarter of the financial year, the Licensee shall pay the License Fee by 25th March on the basis of expected revenue for the quarter, subject to a minimum payment equal to the revenue share paid for the previous quarter."

3. M/s VIL has made short payment of the quarterly License Fee (LF) dues (on self-assessment basis) for Q2 of FY 2023-24 and has thus breached the provisions of the License Agreement. The details of AGR, LF paid and LF due of M/s VIL for Q2 of FY 2023-24 on self-assessment basis (as per SARAS) is as follows:

Summary of License Fee Dues for Quarter2 of FY 2023-24 in respect of M/s Vodafone Idea Limited on self-assessment basis							
Sl.No.	FY	Quarter	AGR (in Rs.)	LF Due (in Rs.)	LF Paid (in Rs.)	Date of payment	Principal Due
1	2023-24	Q2	96,26,54,23,947	7,70,12,33,916	77,06,33,281	13.10.2023	
					18,19,28,268	29.12.2023	
Total (in Rupees)					95,25,61,549	--	6,74,86,72,367
Total (in Crores)					95.25		674.86

4 . In view of the above, you are hereby directed to pay the outstanding License Fee dues for Quarter-2 of FY 2023-24 (based on the self-assessment of the company) along with applicable interest, immediately. Further, it is intimated that in case of failure of payments by M/s VIL, the necessary steps including invocation of Clause 21.5 of the UL License agreement and other relevant clauses shall be taken up by the DoT as per terms and conditions of license agreement.

This issues with the approval of competent authority.

**Signed by Maddipatla
Prasanna Kumari
Date: 25-01-2024 10:42:14**

Director (LFA-I)

Copy to:

1. PS to Member (F), Digital Communications Commission, DoT HQ, New Delhi.
2. Controller General of Communication Accounts (CGCA), Ghitorni, New Delhi.

3. PS to Advisor (F), DoT HQ, New Delhi.
4. Jt.CGCA (Revenue), O/o CGCA, New Delhi.
5. DDG (LFA/LFP/WPF), DoT Hq, New Delhi.

File No:1012/02/2023-WR
Government of India
Ministry of Communications
Department of Telecommunications
(Wireless Planning Finance Division – WR Section)

Dated: xx.01.2024

To
Vodafone Idea Limited,
7th Floor, Konnectus Tower-3,
Bhavbhuti Marg, New Delhi – 110002

Sub: Adjustment of Rs.755.52 crores pursuant to Hon'ble TDSAT order dated 15.12.2023 in MA No.114/2023 in TP 30 of 2019 – Reg.– Reg., Ref : VIL/RCA/January/2024/0112-003 dated 12.01.2024 & VIL/RCA/January/2024/0115-001 dated 15.01.2024

Please refer to the letter cited above.

2. In accordance with the TDSAT order dated December 15, 2023, a total amount of Rs.755.52 crores has been adjusted by DoT. The adjustment was executed in two phases:

a. Recoverable SUC Dues (FY 2019-20 to 2021-22):

The initial adjustment targeted long-pending recoverable Spectrum Usage Charges (SUC) dues. This pertains to the period from FY 2019-20 to 2021-22. Notably, these dues were not subject to any subjudice matter or covered under any moratorium as of the adjustment date.

b. SUC Dues of Q2 FY 2023-24:

Following the adjustment against past dues, the remaining balance was allocated towards the Spectrum Usage Charges (SUC) dues for Q2 of FY 2023-24.

3. This step ensures compliance with the TDSAT order and further contributes to resolving financial obligations within the specified time frame.

4. It is further intimated that M/s VIL's LF & SUC payments on self assessment basis with respect to Q2 & Q3 of FY 2023-24 have become overdue. Necessary action may be taken as per the license agreement.

This issues with the approval of Competent Authority.

Signed by Tanyika Singh
(Tanyika Singh)
Date: 02-02-2024 12:44:27
Director (WR)
Ph:011-23036821

Copy to:

1. **DDG (AS), AS Wing, DoT, Sanchar Bhawan, New Delhi** for information.
2. **Sr. DDG (LFA), DoT, Sanchar Bhawan, New Delhi** for information.
3. **CGCA, NICF Campus, Ghitorni, New Delhi** for kind information and circulating the same to Assessing Authorities.

Government of India
Ministry of Communications
Department of Telecommunications
Wireless Planning and Coordination Wing

6th floor, Sanchar Bhawan,
20, Ashoka Road, New Delhi - 110 001.

No.: L-14010/02/2024-IMT

Date: 10.02.2024

To,
M/s Bharti Airtel Limited/ Bharti Hexacom Limited
Airtel Centre, Plot No. 16, Udyog Vihar, Phase IV,
Gurugram-122015 (Haryana).

Subject: Provisional assignment/extension of the spectrum rights which is expiring in the year 2024, before the conclusion of next spectrum auction (Auction 23-24).

Sir,

Consequent to the acceptance of the terms and conditions in the OM No. L-14010/02/2024-IMT dated 09-02-2024 and receipt of due payment, it has been decided for the provisional assignment/extension of the spectrum rights for the use of spectrum, expiring in 2024, for an interim period of 3 months, as tabulated below:

LSA	Frequency Bands in MHz	Quantum of Paired Spectrum (in MHz)	Start Date	End Date
Bihar	1800	3	10-02-2024	09-05-2024
	900	6.2	10-02-2024	09-05-2024
Jammu & Kashmir	900	6.2	10-02-2024	09-05-2024
Odisha	1800	0.6	10-02-2024	09-05-2024
	900	6.2	10-02-2024	09-05-2024
Uttar Pradesh (East)	1800	1	10-02-2024	09-05-2024
	900	6.2	10-02-2024	09-05-2024
West Bengal	1800	1.8	11-02-2024	10-05-2024
	900	4.4	11-02-2024	10-05-2024

2. For this interim period, all Terms and Conditions of Auction 22-23, as per NIA 2022 dated 15-06-2022, shall be applicable. Other relevant terms and conditions for the use of spectrum shall be as per assignment letters issued to successful bidders, post Auction 22-23.

Vineeth

(Vineeth Kurian Mathew)

Assistant Wireless Advisor to the Govt. of India

Copy to:

1. DDG(WPF), Sanchar Bhavan, New Delhi.
2. DDG(AS), Sanchar Bhavan, New Delhi.
3. Director (WMO), Pushpa Bhavan, New Delhi.

Government of India
Ministry of Communications
Department of Telecommunications
Wireless Planning and Coordination Wing

6th floor, Sanchar Bhawan,
20, Ashoka Road, New Delhi - 110 001.

No.: L-14010/02/2024-IMT

Date: 13.02.2024

To,
M/s Vodafone Idea Limited
7th floor, "Konnectus", Tower B, Bhavbhuti Marg,
Opposite New Delhi Railway Station (Ajmeri gate side),
New Delhi - 110 002.

Subject: Provisional assignment/extension of the spectrum rights which is expiring in the year 2024, before the conclusion of next spectrum auction (Auction 23-24).

Sir,

Consequent to the acceptance of the terms and conditions in the OM No. L-14010/02/2024-IMT dated 09-02-2024 and receipt of due payment, it has been decided for the provisional assignment/extension of the spectrum rights for the use of spectrum, expiring in 2024, for an interim period of 3 months, as tabulated below:

LSA	Frequency Bands in MHz	Quantum of Paired Spectrum (in MHz)	Start Date	End Date
Uttar Pradesh (West)	900	5	13-02-2024	12-05-2024

2. For this interim period, all Terms and Conditions of Auction 22-23, as per NIA 2022 dated 15-06-2022, shall be applicable. Other relevant terms and conditions for the use of spectrum shall be as per assignment letters issued to successful bidders, post Auction 22-23.

Vineeth

(Vineeth Kurian Mathew)

Assistant Wireless Advisor to the Govt. of India

Copy to:

1. DDG(WPF), Sanchar Bhavan, New Delhi.
2. DDG(AS), Sanchar Bhavan, New Delhi.
3. Director (WMO), Pushpa Bhavan, New Delhi.

Fwd: Clarification regarding surrender of MWB by M/s TTML.

From : Tanvika Singh <singh.tanvika@gov.in>
Subject : Fwd: Clarification regarding surrender of MWB by M/s TTML.

Wed, Feb 14, 2024 01:12 PM

📎 1 attachment

To : Christeena Joy <assttcgcarev-dot@gov.in>
Cc : Shivendu Gupta <shivendu.gupta@gov.in>, Avneesh Kumar <avneesh.86@gov.in>, Pratima Singh <dycgcarev-dot@gov.in>, cca mhgoa <cca.mhgoa@gmail.com>, CCA MH Goa <cca.mhgoa-dot@gov.in>, HITHENDRA CHARY <wpf.wr-dot@gov.in>, ccamumbai@gmail.com, caolfccaup@gmail.com

Sir/Madam,

Please refer to the trail mail on the subject cited above.

The WPC wing letter No. L-14042/01/2019-NTG, dated 20.09.2023 is hereby verified.

Regards,

Tanvika Singh,
Director (WR),

From: "Shivendu Gupta" <shivendu.gupta@gov.in>
To: "Tanvika Singh" <singh.tanvika@gov.in>
Sent: Tuesday, February 13, 2024 1:41:25 PM
Subject: Fwd: Clarification regarding surrender of MWB by M/s TTML.

for n/a

From: "Christeena Joy" <assttcgcarev-dot@gov.in>
To: "Shivendu Gupta" <shivendu.gupta@gov.in>
Cc: "Ashish Joshi" <jtgcgcarev-dot@gov.in>, "Pratima Singh" <dycgcarev-dot@gov.in>, "G S S Nikhil Bharadwaj" <acao1rev-dot@gov.in>, "Rupa Boddu" <rupa.boddu@gov.in>, "cca mhgoa" <cca.mhgoa@gmail.com>, "CCA MH Goa" <cca.mhgoa-dot@gov.in>
Sent: Monday, February 12, 2024 6:08:56 PM
Subject: Clarification regarding surrender of MWB by M/s TTML.

Respected Sir/Madam,

Please find the trailing mail received from CCA MH&Goa regarding WPC wing letter No. L-14042/01/2019-NTG dated 20.09.2023 (attached herein), which was given by TSP to CCA

File No. L-14042/01/2019-NTG
 Government of India
 Ministry of Communications
 Department of Telecommunications
Wireless Planning & Coordination Wing

6th floor, Sanchar Bhawan,
 20, Ashoka Road, New Delhi – 110001

No.: L-14042/01/2019-NTG

Date: 20.09.2023

To,

Tata Teleservices Limited (TTSL)/
 Tata Teleservices (Maharashtra) Limited (TTML)
 2-A, old Ishwar Nagar, Main Mathura Road,
 New Delhi – 110 001

Subject: Surrender of Microwave Access (MWA) and Microwave Backbone (MWB spectrum in Maharashtra, Mumbai and UP (East) service areas.

Ref: 1. TTML letter no. TTML/surrender/WPC/270/2023 dated 02.08.2023.
 2. TTSL letter no. TTML/MW-surrender/WPC/269/2023 dated 02.08.2023.

Sir,

I am directed to refer to your above-referred letters on the above-mentioned subject and to convey that surrender of Microwave carriers has been accepted and taken on record in Maharashtra, Mumbai and UP (East) LSAs as detailed below:

Sl. No	Service Area	Carrier Frequency in MHz (28 MHz Bandwidth)	Effective date of Surrender
1	Maharashtra	7470/ 7624	30-09-2016
2	Mumbai	14767/ 15187	31-12-2013
3	UP (East)	7498/ 7652	30-06-2017

2. Dues towards spectrum usage charges, if any, as per prevailing provisions, i.r.o. the above-mentioned MWA/MWB carriers till the effective date of surrender would be payable by you
3. The other terms and conditions of surrender guidelines no. L-14042/01/2022-IMT dated 10-11-2022 shall be applicable.

(Avneesh Kumar),

Signed by Avneesh Kumar, Assistant Wireless Adviser
 Date: 20-09-2023 18:29:49 to the Government of India

Reason: Approved

Copy to:

1. DDG (WPF), DoT, Sanchar Bhawan, New Delhi, for computation and realization of necessary spectrum charges dues.
2. Director (WMO), Wireless Monitoring Organization (HQ), Pushpa Bhawan, New Delhi – 110 062, for information please.

Email

Pratima Singh

Circulation of WPC orders relating to surrender of MW Carriers - Reg.,

From : Tanvika Singh <singh.tanvika@gov.in> Thu, Feb 15, 2024 02:17 PM
Subject : Circulation of WPC orders relating to surrender of MW Carriers - Reg., 2 attachments
To : Pratima Singh <dycgcarev-dot@gov.in>, Christeena Joy <assttcgcarev-dot@gov.in>
Cc : Ms. Anuradha Joshi Durgapal <cgca-dot@gov.in>, Nirdosh Kumar Yadav <ccaupwest.me-up@nic.in>, Shivendu Gupta <shivendu.gupta@gov.in>, HITHENDRA CHARY <wpf.wr-dot@gov.in>

Sir/Madam,

This is in response to the Lr. No.CCA/UPW/Bharti Airtel/SUC Assessment/2021-22/659, dated 02.02.2024.

The following WPC orders are verified:

1. L-14043/01/2014-NTG, dated 10.08.2018 regarding surrender of MW carriers of M/s.Telenor
2. L- 14042/01/2019-NTG, dated 09.05.2019 regarding surrender of MW carriers of M/s.TTSL/TTML

The above said orders are also uploaded in knowledge bank of SARAS.

Further, it is requested to circulate the orders to Assessing Authorities for necessary action.

Regards,

Tanvika Singh,
Director (WR)
WPF Wing, DoT HQ
New Delhi-110 001



 **TTSL MWA & MWB surrender-09.05.2019.pdf**
2 MB

 **Telenor order.pdf**
503 KB

m

Government of India
Ministry of Communications
Department of Telecommunications
Wireless Planning & Coordination Wing

6th floor, Sanchar Bhawan,
20, Ashoka Road, New Delhi - 110001.

No.: L-14042/01/2019-NTG

Date: 09.05.2019

To,

- | | |
|-------------------------------------------------------------------------------------------------------------------------------------------------------------------|----------------------------------------------------------------------------------------------------------------------------|
| 1. Tata Teleservices Limited (TTSL)/
Tata Teleservices (Maharashtra) Limited
(TTML)
2-A, old Ishwar Nagar,
Main Mathura Road,
New Delhi - 110 001. | 2. Bharti Airtel Limited,
Bharti Crescent,
1, Nelson Mandela Road,
Vasant Kunj, Phase II,
New Delhi - 110 070. |
|-------------------------------------------------------------------------------------------------------------------------------------------------------------------|----------------------------------------------------------------------------------------------------------------------------|

Subject: Surrender/transfer of Microwave Access (MWA) and Microwave Backbone (MWB) spectrum in Delhi, Gujarat, Haryana, Karnataka, Kerala, Madhya Pradesh, Punjab, Rajasthan, Tamil Nadu (including Chennai) and Uttar Pradesh (West) service areas.

Sir,

I am directed to refer to your letter dated 04.12.2018 on the above-mentioned subject and to inform that your request for surrender of Microwave Access (MWA) and Microwave Backbone (MWB) carriers (details mentioned in Annexure) in Delhi, Gujarat, Haryana, Karnataka, Kerala, Madhya Pradesh, Punjab, Rajasthan, Tamil Nadu (including Chennai) and Uttar Pradesh (West) service areas has been accepted the effective date of TTSL/TTML Scheme (of merger with M/s Bharti).

2. It may further be noted that MWA-MWB spectrum retained by M/s TTSL in the above-mentioned LSAs would be assigned to Bharti group post-merger only after submitting a joint undertaking to the effect that M/s Bharti/the merged entity would be paying 2006 rates i.r.o. MWA-MWB spectrum transferred from M/s TTSL and will abide by the final decision of the Government on the allocation of MWA/MWB carriers including any cap on the number of maximum carriers as may be decided by Department and applicable to all the TSPs.

3. In view of the above, it is requested that the joint undertaking in this regard may kindly be submitted for further necessary action in the matter.

4. Dues towards spectrum usage charges etc. i.r.o. the surrendered spectrum would be payable till the effective date of surrender.

Vinith

Assistant Wireless Adviser
to the Government of India

. Copy to:

1. DDG (WPF), DoT, Sanchar Bhawan, New Delhi, for necessary action i.r.o. recovery of dues related to spectrum.
2. Director (WMO), Wireless Monitoring Organization (HQ), Pushpa Bhawan, New Delhi - 110 062, for information.

Details of MW/A/MWB spectrum surrendered by TTSL/TTML

Sl. No	Service Area	Carrier Frequency in MHz (28 MHz Bandwidth)	Allotted for CDMA and/or GSM	Assignment Reference
1	Delhi	18332.5/19342.5	CDMA	J-14025/3(2/MW)/2002-NT dated 19.10.2004
		18360.0/19370.0	CDMA	
		18387.5/19397.50	CDMA	
2	Gujarat	17920.0/18930.0	CDMA & GSM	J-14025/3(3/MW)/2002-NT dated 31.10.2002, GSM authorization through L-14048/08/2008-NTG dated 08-07-2009
		17865.0/18875.0	CDMA & GSM	
		7498.0/7652.0		
3	Haryana	14851.0/15271.0	CDMA & GSM	J-14025/3(33)/2004-NT dated 13.10.2004 J-14025/3(42)/2004-NT dated 01.09.2004, GSM authorization through L-14048/07/2009-NTG dated 03-07-2009
		7442.0/7596.0	CDMA & GSM	
4	Karnataka	14655.0/15075.0	CDMA & GSM	J-14025/3(24)/2004-NT dated 01.02.2004, GSM authorization through L-14048/07/2009-NTG dated 03-07-2009
		17865.0/18875.0	CDMA & GSM	
		17920.0/18930.0	CDMA & GSM	
5	Kerala	14851.0/15271.0	CDMA & GSM	J-14025/3(38)/2004-NT dated 01.09.2004, GSM authorization through L-14048/01/2008-NTG dated 24-08-2009
		17727.5/18737.5	CDMA & GSM	
6	Madhya Pradesh	17727.5/18737.5	CDMA & GSM	J-14025/3(44)/2004-NT dated 01.09.2004, GSM authorization through L-14048/05/2008-NTG dated 06-08-2009

		7554.0/7708.0	CDMA & GSM	J-14025/3(26)/2004-NT dated 05.10.2004, GSM authorization through L-14048/05/2008-NTG dated 06-08-2009
7	Punjab	17727.5/18737.5	CDMA & GSM	J-14025/3(40)/2004-NT dated 01.09.2004, GSM authorization through L-14048/12/2008-NTG dated 22-06-2009
		7442.0/7596.0	CDMA & GSM	J-14025/3(23)/2004-NT dated 03.08.2005, GSM authorization through L-14048/12/2008-NTG dated 22-06-2009
		17727.5/18737.5	CDMA & GSM	J-14025/3(41)/2004-NT dated 01.09.2004, GSM authorization through L-14048/06/2009-NTG dated 22-06-2009
8	Rajasthan	7526.0/7680.0	CDMA & GSM	J-14025/3(18)/2004-NT dated 27.01.2006, GSM authorization through L-14048/06/2009-NTG dated 22-06-2009
		7554.0/7708.0	CDMA & GSM	J-14025/3(18)/2004-NT dated 02.12.2004, GSM authorization through L-14048/06/2009-NTG dated 22-06-2009
		14823.0/15243.0		
	Tamil Nadu (Excluding Chennai)	17865.0/18875.0	CDMA & GSM	J-14025/3(4)/MW/2003-NT dated 22.07.2005, GSM authorization through L-14048/55/2007-NTG dated 28-08-2009
		18167.5/19177.5	GSM	L-14043/55/2007-NTG dated 30.06.2008
		18030.0/19040.0	CDMA & GSM	J-14025/3(4)/MW/2003-NT dated 22.07.2005, GSM authorization through L-14048/55/2007-NTG dated 28-08-2009
	Tamilnadu (Chennai only)	14823.0/15243.0	CDMA & GSM	
		17865.0/18875.0	CDMA & GSM	
		18167.5/19177.5	GSM	L-14043/55/2007-NTG dated 30.06.2008
10	UP (West)	17727.5/18737.5	CDMA & GSM	J-14025/3(43)/2004-NT dated 22.09.2004, GSM authorization through L-14048/09/2009-NTG dated 15-07-2009



File No:1034/05/2023-WR
Government of India
Ministry of Communications
Department of Telecommunications
(Wireless Planning Finance Division – WR Section)

To
 The CGCA,
 NICF Campus,
 Ghitorni, New Delhi – 110047

Dated: xx.02.2024

Sub: Clarification on applying Spectrum Usage Charges (SUC) in cases of Spectrum Sharing – Reg.,

Ref: 1. DoT Lr. No.1000/01/2020-WR, dated 11.10.2022
2. DoT Lr. No. 1000/01/2020-WR, dated 27.01.2023

Please refer to the OM No.1000/01/2020-WR, dated 11.10.2022 wherein the Methodology for arriving at SUC rate in cases of Spectrum Sharing was circulated.

2. Pursuant to TDSAT order dated 09.01.2023 in TP No.01/2023, the OM dated 11.10.2022 on the subject was kept under abeyance till further orders, vide letter dated 27.01.2023. Presently, the case is still pending in Hon'ble TDSAT.

3. Hence, Assessing Authorities may do SUC assessment of M/s.RJIL, for the years not included in AGR judgement by Hon'ble SC, as follows:

- i. The SUC assessment may be done by both ways i.e. by applying additional sharing rate of 0.5% on band in which sharing is taking place and by applying additional sharing rate of 0.5% on overall SUC weighted Average Rate (WAR).
- ii. The SUC assessment done by applying additional sharing rate of 0.5% on band in which sharing is taking place, shall be issued to the licensee.
- iii. The difference between assessed amount post application of additional SUC @ 0.5% on overall WAR and the SUC @0.5% on specific band shall be categorized as amount under litigation.
- iv. Disclaimer is to be inserted in the Demand Note that "***The additional SUC rate of 0.5% applied on band is subject to outcome of the case in Hon'ble TDSAT in TP-01/2023. Department reserves the right to revise the demand notes as per the Hon'ble TDSAT order or any other instructions from DoT Hq***"
- v. Surplus SUC amount paid by the TSP beyond the assessed amount as detailed in (ii) above (i.e. after applying additional sharing rate of 0.5% on band which is being shared) shall be adjusted as per extant guidelines.

This is issued with the approval of Competent Authority.

(Tanvika Singh)
 Director (WR)
 Ph:011-23036821

Government of India
Ministry of Communications
Department of Telecommunications
Wireless Planning & Coordination Wing
Sanchar Bhawan, 20, Ashoka Road, New Delhi - 110001.

No.: L-14043/01/2014-NTG

To,

Date: 10/08/2018

M/s Bharti Airtel Limited
Bharti Crescent, 1, Nelson Mandela Road,
Vasant Kunj, Pahse II,
New Delhi-110070

Subject: Surrender of Microwave Access(MWA) carriers in Andhra Pradesh, Gujrat, Maharashtra, UP(West) service areas w.e.f. 30/06/2018 and in Bihar, UP(East) service areas w.e.f. 30/09/2018.
Ref: WPC letter no. L-14043/01/2014-NTG dated 07/07/2014.

Sir,

I am directed to refer to letters dated 28.03.2018, 02.04.2018 and 30.04.2018 from M/s Telenor(India) Communications Pvt. Ltd. and your letter No. RP/FY 18-19/062/522 dated 26.06.2018 on the above mentioned subject and to inform you that requests for surrender of Microwave Access carriers assigned vide above reference no. have been provisionally accepted for service areas namely Andhra Pradesh, Gujrat, Maharashtra and UP (West) w.e.f. 30.06.2018 and for service areas namely Bihar and UP (East) w.e.f. 30.09.2018, subject to the payment of spectrum charges due, if any, i.r.o. surrendered carriers up to the date of acceptance of surrender.

Shitanshu Shekhar
(Shitanshu Shekhar)
Engineer (V)

Copy to:

1. DDG(WPF) for information and further action.
2. Director (WMO), MHQ, Pushpa Bhawan, New Delhi.
3. DDG(AS) for information.
4. Sr. DWA(ASMS), with the request to delete relevant records from ASMS server.
5. M/s Telenor(India) Communications Pvt. Ltd.





GOVERNMENT OF INDIA
Ministry of Communications
Department of Telecommunications
Office of the Principal Controller of Communication Accounts
Tamil Nadu Circle

73
**SPEED POST
WITHOUT PREJUDICE**



ISO 9001:2015

F. No. PCCA/TN/LF-I/2008-09/AGR STT-PC/Unitech-TN / 10575

Dated the 28th February, 2024

To

M/s. Unitech Wireless (Tamilnadu) Private Limited,
Office Number 1202, Avanta Business Centre,
12th Floor, Ambadeep Building,
Kasturba Gandhi Marg,
Connaught Place, New Delhi – 110 001.

Sub: Final SUC assessment in respect of M/s. Unitech Wireless Ltd. for the financial year 2008-09 for Tamilnadu Service area.
Ref: Your letter dated 07.07.2023

1. This is for final assessment of annual SUC dues for the financial year 2008-09 of M/s. Unitech Wireless Ltd., for Tamil Nadu Service area.

2. Summary of assessment are as follows:-

AGR as per DoT	Spectrum type	SUC due	SUC paid	Difference	Int. on Pr.	Penalty & Int. on penalty	Total Excess
6996240	GSM- Main	139925	149566	-9641	7912	0	-1729
	GSM-MWA	24487	26174	-1687	1385	0	-302
	GSM-MWB	2030	11217	-9187	48	0	-9139
Total		166442	186957	-20515	9345	0	-11170

3. This Annual Assessment is based on the following documents:-

- AGR determined by LF wing of DoT Hqrs. Vide No. 17-17/2012/LF-II dated 08.10.2012.
- Rate of SUC in respect of GSM access spectrum has been taken based on DOT HQ WPC letter No P-11014/18/2008-PP dated 25.02.2010.
- Rate of SUC in respect of MWA & MWB have been taken based on WPC Wing, DoT HQ letter No. J-14025/200(11)/06-NT dated 03.11.2006.
- Interest is charged at the rate of PLR (12.25) + 2% as on 01.04.2008 upto 31.10.2019 and at 8% from 1.11.2019 as per DoT Hqrs instruction for moratorium vide letter No. 19-2/2022/LFA/ Outstanding Dues dated 3.11.2022.

4. The calculation sheet for computation of AGR and interest amount is annexed with this letter.

5. Representation, if any, may be addressed to this Office within 15 days of receipt of this letter, failing which it would be presumed that Company has nothing to say in this matter.

6. This notice is subject to E & O E (Errors and Omissions Excepted).

...2/-

238, RK Mutt Road, RK Nagar Telephone Exchange, 7th Floor, Mandaveli, Chennai-600028
044-24955824, Fax: 044-24955820, e-mail:- dyccalfuso.ccatn@nic.in

7. The amount communicated vide this Show Cause Cum Demand Notice for this FY are not included in AGR dues crystallized by Hon'ble Supreme court in its judgement dated 20.07.2020.
8. This is subject to revision on receipt of any further updated AGR from DOT HQ, any orders of court or any instructions from DOT-HQ.

This issues with the approval of the Competent Authority.

Receipt of this demand may kindly be acknowledged.

Encl.: Calculation sheets for FY 2008-09

A. Sajith Kumar

Jt. Controller of Communication Accounts
O/o Pr. CCA, DoT, TNCircle, Chennai – 600 028

Fwd: Revival of BSNL – Payment of SUC dues upto the FY 2021-22 – Reg.,

From : Christeena Joy <assttcgcarev-dot@gov.in>
Subject : Fwd: Revival of BSNL – Payment of SUC dues upto the FY 2021-22 – Reg.,
To : G Venkata Bhavani <aolf.ccaap-dot@gov.in>, CCA, AP <cca-ap@nic.in>, dbacca-ap@nic.in, Lopamudra Mohanty <ccaassam@nic.in>, ccaassam@gmail.com, CCA Bihar <cca-bih@nic.in>, lfsectionccabihar@gmail.com, CCA CHHATISGARH <cca.cg-dot@nic.in>, ccadelhi@gmail.com, revenue ccadelhi <revenue.ccadelhi@gmail.com>, CCA Gujarat <cca.guj-dot@nic.in>, ccaryana@gmail.com, cca revenue-rj <cca.revenue-rj@gov.in>, MAYANK NEGI <cca-telecom-hp@nic.in>, CCA-HR-REV <aorevcca.amb-dot@gov.in>, CCA JK <ccajk@nic.in>, Dipankar Mahto <cca.jh-dot@nic.in>, Geethanjali H.C <aolf.ccakar-dot@gov.in>, Ranganath Shyam <ccatrivandrum@nic.in>, pccakolkata@gmail.com, HARI GOVIND SINGH DHAKAD <cca.mp-dot@nic.in>, Chetram Meena <dyccalfdot-mp@nic.in>, cca mhgoa <cca.mhgoa@gmail.com>, ccamumbai@gmail.com, ccaneortheast@gmail.com, ccane1 lfsuc <ccane1.lfsuc@gmail.com>, ccane2dimapur@gmail.com, CCA ODISHA <ccaodisha.dot@nic.in>, CCA Punjab <cca.pb-dot@nic.in>, CCA Rajasthan <cca-jaip-rj-dot@nic.in>, CCA Tamilnadu <ccatn.tn@nic.in>, Deputy Controller of Communication Accounts <dyccalfuso.ccatn@nic.in>, ccalfhyd@gmail.com, Sangeet Kumar <cca.upeast@gov.in>, caolfccaupe@gmail.com, ccaupwest@gmail.com, Nirdosh Kumar Yadav <ccaupwest.me-up@nic.in>, Anju Lata <jtccaupwest.me-up@nic.in>, CCA Dehradun <ccaddn-dot@nic.in>, ccadehradun@rediffmail.com, BB Joshi <jtcca.ddn-dot@gov.in>, CCA WB <ccawbc-dot@nic.in>, AO LF <ao-licensefee@ccakolkata.gov.in>
Cc : Ashish Joshi <jtgcgcarev-dot@gov.in>, Pratima Singh <dygcgcarev-dot@gov.in>, Tanvika Singh <singh.tanvika@gov.in>, G Sessa <gssn.bharadwaj@gov.in>, roopashree 10047058 <roopashree.10047058@gov.in>, Deepa Gurnani <deepa.gurnani05@gov.in>, Kavya S <kavya.s48@gov.in>

Wed, Mar 13, 2024 10:43 AM

compendium

Respected Sir/Madam,

With respect to the subject cited above, kindly find the trailing mail dated 12.03.2024 received from WR Section for information and further necessary action please.

With regards

Christeena Joy
Asstt.CGCA (Revenue)
O/o CGCA, NICF Campus
Ghitorni
New Delhi 110047

From: "Tanvika Singh" <singh.tanvika@gov.in>
To: "Pratima Singh" <dycgcarev-dot@gov.in>, "Christeena Joy" <assttcgcarev-dot@gov.in>
Cc: "Shivendu Gupta" <shivendu.gupta@gov.in>, "Ashish Joshi" <ashish.joshi@nic.in>, "HITHENDRA CHARY" <wpf.wr-dot@gov.in>, "CGCA" <cgca-dot@gov.in>, "SRIKANTA PANDA" <addcgca-dot@gov.in>
Sent: Tuesday, March 12, 2024 5:02:00 PM
Subject: Fwd: Revival of BSNL – Payment of SUC dues upto the FY 2021-22 – Reg.,

Sir/Madam,

This is regarding payments made by BSNL towards SUC dues for the FYs not included in Hon'ble Supreme Court AGR judgement dated 01.09.2020 (as the same has been funded as part equity infusion by Government).

It is intimated that SUC payments w.r.t BSNL for FYs not included in AGR judgment upto FY 2021-22 and for FY 2022-23 has been done centrally at DoT.

In this context, it is requested to communicate the following to the Assessing Authorities:

- i. The SUC dues of BSNL upto FY 2021-22 for the FYs not included in Hon'ble Supreme Court AGR judgement dated 01.09.2020 (Demand notes raised upto NOV-2022 and reported to DoT) may be treated as paid.
- ii. The SUC dues of BSNL for the FY 2022-23 (for the demand notes raised by Assessing authorities in OCT-2023) submitted by O/o CGCA vide email dated 12.10.2023 may be treated as paid.

Hence, Assessing Authorities may be instructed to incorporate this payment information in their records.

Regards,

Tanvika Singh,
Director (WR)
WPF Wing, DoT HQ
New Delhi-110 001

From: "Tanvika Singh" <singh.tanvika@gov.in>
To: "Pratima Singh" <dycgcarev-dot@gov.in>, "CHRISTEENA JOY" <acao1rev-dot@gov.in>
Cc: "Shivendu Gupta" <shivendu.gupta@gov.in>, "Ashish Joshi" <ashish.joshi@nic.in>, "HITHENDRA CHARY" <wpf.wr-dot@gov.in>
Sent: Friday, June 30, 2023 5:25:58 PM
Subject: Revival of BSNL – Payment of SUC dues upto the FY 2021-22 – Reg.,

Sir/Madam,

It is requested to intimate all the CCA offices, that the SUC dues of BSNL upto FY 2021-22 (for the FYs not included in Hon'ble Supreme Court AGR judgement dated 01.09.2020) may be treated as paid, as the same has been funded as part equity infusion by Government.

This payment information may be incorporated by CCA offices in their records.

Regards,

Tanvika Singh,
Director (WR)
WPF Wing, DoT HQ
New Delhi-110 001



सत्यमेव जयते

File No:1034/01/2024-WR
• **Government of India**
Ministry of Communications
Department of Telecommunications
(Wireless Planning Finance Division – WR Section)

To
M/s.Unitech Wireless (Tamilnadu) Pvt. Limited,
Office No.1202, Avanta Business Centre,
12th Floor, Ambadeep Building,
Kasturba Gandhi Marg, Connaught Place,
New Delhi-110001.

Dated: xx.04.2024

Sub: SUC claims pertaining to UASL Licenses issued to M/s.Unitech Wireless (Tamil Nadu) Private Limited – Reg.,
Ref: Your letter dated 09.02.2024

Please refer to the letter cited above on the subject.

2. In this regard, the SUC dues for the years not included in the AGR judgment for M/s Unitech are detailed in Annexure-A.
3. There are differences in the SUC dues in Annexure-A vis-a-vis the SUC dues submitted by your office due to the variation in the date till which interest has been calculated by the Assessing Authorities (copies of revised demand notes enclosed).
4. Further, the details of the adjustment of the encashed BGs of Unitech along with the balance unadjusted BGs is provided in Annexure-B.
4. Please note that interest shall be payable as on date of clearing of outstanding dues, as per License conditions/2nd moratorium conditions,.

This has approval of the Competent Authority.

Signed by Tanvika Singh
Date: 02-04-2024 16:24:35
(Tanvika Singh)
Director (WR)
Ph:011-23036821

Copy to:

The CGCA, NICF Campus, Ghitorni, New Delhi for further necessary action and with a request to circulate the same to Assessing Authorities.

Email

1124866(M/F)

Manish Sinha

Final Minutes of the Eastern Zone Conference on SUC held on 1st & 2nd March, 2024 at Bihar Circle, Patna- reg.

From : CCA Bihar <cca-bih@nic.in>

Wed, Apr 10, 2024 06:10 PM

Subject : Final Minutes of the Eastern Zone Conference on SUC held on 1st & 2nd March, 2024 at Bihar Circle, Patna- reg.

1 attachment

638/AF/24

12/4/24

To : Manish Sinha <memberf-dot@nic.in>, Pcca Kolkata <pcca@ccakolkata.gov.in>, pccakolkata@gmail.com, Abhay Kr. Singh <abhaykr.singh69@nic.in>, Shivendu Gupta <shivendu.gupta@gov.in>, CCA Ccakol <cca@ccakolkata.gov.in>, Dipankar Mahto <cca.jh-dot@nic.in>, Lopamudra Mohanty <ccaassam@nic.in>, CCA WB <ccawbc-dot@nic.in>, CCA NE II Circle <ccane2-dot@gov.in>, CCA NE Circle <ccane1-meg@nic.in>

[Handwritten signature] 12/24
Addl (F. & C.)

[Handwritten signature] (W/P/F)

3/12/4

[Handwritten signature]
R. Sinha

[Handwritten signature]
22/4

Respected Sir/Madam,

Kindly find an attachment on the subject mentioned above.

With regards.

O/o CCA Bihar



Minutes of Eastgern Zone Conference.pdf
2 MB



Government of India
Ministry of Communications
Department of Telecommunications
O/o Controller of Communication Accounts
Bihar Circle, CCA Building, Sanchar Parisar, BudhMarg,
Patna-800001, Ph.-0612-2223508, E-mail: CCA-bih@nic.in

No. CCABR/07/E.Z.R.Meeting/469/2023-24/33

Dated: 10 April, 2024

Sub: Final Minutes of the Eastern Zone Conference on SUC held on 1st & 2nd March, 2024 at Bihar Circle, Patna-reg.

The Eastern Zone Review Meeting on Revenue and Spectrum related matters was held on 01.03.2024 & 02.03.2024 at Patna, Bihar, under the chairmanship of Respected Member (F) & DCC, Sh. Manish Sinha, with Pr. CCA, Kolkata, Dr. Shikha Mathur Kumar and all the Circle Heads of Eastern Zone along with their team members in attendance. The following officers and officials were present in the meeting:

- | | |
|----------------------------|---------------------------------|
| 1. Sh. Manish Sinha | : Member (F), DCC - Chairperson |
| 2. Dr. Shikha Mathur Kumar | : Pr. CCA, Kolkata |
| 3. Sh. Abhay Kumar Singh | : DDG (NICF) |
| 4. Sh. Rajeev Kumar | : CCA (Bihar) |
| 5. Sh. Shivendu Gupta | : DDG (WPF) |
| 6. Sh. Dalzakam Valte | : CCA (Kolkata) |
| 7. Sh. Dipankar Mahto | : CCA (Jharkhand) |
| 8. Smt. Lopamudra Mohanty | : CCA (Assam) |
| 9. Sh. Shubhranil Das | : Jt. CCA (WB) |
| 10. Sh. Vivek Drolia | : Jt. CCA (Pr. CCA, Kolkata) |
| 11. Sh. K. Sajal | : Jt. CCA (NE-II) |
| 12. Sh. Alok Kumar Pandey | : Jt. CCA (Bihar) |
| 13. Sh. Abhilash P | : Jt. CCA (JH) |

and officers/officials from all the circles of the Eastern Zone.

The meeting started with the welcome note by Sh. Alok Kumar Pandey, Jt. CCA (Bihar). Further, Sh. Rajeev Kumar, CCA (Bihar) formally welcomed all the respected participants of Eastern Zone Review Conference and invited Pr.CCA, Dr. Shikha Mathur Kumar to felicitate Respected Member (F) & DCC.

Pr. CCA, Kolkata, Dr. Shikha Mathur Kumar in her inaugural address mentioned that the main agenda of the meeting is to have a clear picture of undisputed outstanding SUC dues and formulate a strategy to clear these dues on priority. She mentioned that healthy discussions on SARAS, Calculation of SUC, Spectrum

Holdings and Spectrum Auctions in the review meet will be very fruitful and will provide a better clarity to all the participants. She hoped that this Conference would be a great opportunity for all the officers/officials present, as this would result in sharing of knowledge and best practices among all circles. She also mentioned that the discussion would be fruitful if we achieve the target of recovery before the end of this financial year. Pr. CCA then requested Respected Member (F) & DCC to address the gathering.

Respected Member (F), DCC during his keynote address mentioned that the CCAs are responsible for realizing outstanding SUC dues and they should be focused on all outstanding SUC dues other than the disputed amount. Further, Member (F) asked to differentiate between the disputed and undisputed amount of outstanding SUC dues clearly. Member (F) motivated and directed all the officers/officials at every level to put their best efforts for the SUC assessment to avoid frequent updation of the outstanding dues which need to be finalized in totality.

He suggested proper documentation and urged not to hesitate to give time to the stakeholders for settlement of undisputed outstanding SUC dues. He also advised to approve the AGR excluding Wireline, Spectrum Holdings and Weighted Average Rate firstly from all levels. After that, the calculation of SUC should be put up for approval to avoid any error while calculating SUC outstanding dues. Further, he mentioned that before issuing demands to the TSPs, a formal meeting should be conducted to minimize the discrepancies and realize the SUC dues.

Post the keynote address by Respected Member (F), a handbook named "AANKLAN", on the best practices adopted by O/o Pr.CCA, Kolkata in the assessment of decentralized licensees was released by Member (F), DCC along with other senior dignitaries.

The first session was taken up by Sh. Shivendu Gupta, DDG (WPF Wing), DoT HQ. He discussed all the aspects of SUC calculation, Spectrum Holdings, SARAS related issues, circulars and guidelines issued by DoT HQ time to time. He mentioned that no clarification of SUC related issue is pending as on date at the end of DoT HQ and SARAS is now compatible to do SUC assessment properly. The following points have been discussed by DDG (WPF):

1. WR section has issued clarifications on applying SUC in cases of spectrum sharing vide their letter No. 1034/05/2023-WR dated 26.02.2024 and 1012/01/2023-SF (P1-II) dated 28.02.2024.
2. OM No. P-14010/05/2016 dated 12.08.2016 may be followed for calculation of floor amount.

3. Illustrations regarding SUC rate calculation has been circulated vide OM No. 1000/10/2022-WR dated 19.12.2022 and corrigendum dated 13.01.2023.
4. The payment of the SUC dues pertaining to FYs included in the Hon'ble Supreme Court Judgment is being monitored centrally. Efforts are to be taken to realize and recover the SUC dues which are not included in the Hon'ble Supreme Court and Moratorium.
5. Surplus adjustment will be done in respect of LF and SUC as per OM No 1-9/2019-LFP-I dated 09.10.2019 and 18.10.2022.
6. The calculation of interest in respect of 2nd Moratorium is detailed in OM No 19-2/2022/LFA/Outstanding dues dated 03.11.2022.
7. DDG (WPF) also emphasized that Assessing Authority should conduct meetings with TSPs to minimize the discrepancy and realize the outstanding dues before issuing Demand Notices and the minutes should be issued thereof so that the undisputed outstanding SUC dues may be recovered.

This was followed by a healthy Q&A session with all circles getting various clarifications and valuable guidance from DDG, WPF.

Further, Sh. Abhay Kumar Singh, DDG (NICF) addressed the gathering and mentioned that NICF is a good platform to discuss various issues of LF, SUC and Spectrum related matters. He assured that a workshop will be conducted for all the officers and officials of Department of Telecom entrusted with the work of LF and SUC assessment. He described the aspects and importance of iGOT Mission Karmayogi and encouraged all participants to utilize the opportunity fruitfully. He also mentioned that World Telecom Standardization Assembly-2024 is going to be held at Pragati Maidan, New Delhi from 14th to 24th Oct, 2024 and encouraged healthy participation.

Sh. DalzakamValte, CCA West Bengal and Kolkata then discussed the issues and outstanding dues related to SUC for Pr.CCA, Kolkata and CCA, West Bengal Circle and how efforts are being made to realize the same at the earliest. It was also highlighted by the officer that during the approval of SUC Assessment through SARAS, no e-sign is required but it is applicable for LF Assessment of ISPs. Therefore, CCA West Bengal and Kolkata has requested to DoT (HQ) to take up the matter with SARAS helpdesk.

Sh. Alok Kumar Pandey, Jt.CCA, Bihar presented the current position and issues w.r.t. the Bihar Circle. Respected Member (F), DCC asked to submit the undisputed SUC dues in r/o M/s VIL to WPF section DoT HQ, New Delhi post the recent revision for adjustment of the same. In connection with BSNL SUC outstanding dues, Respected Member (F) instructed to settle the SUC outstanding dues as these dues had already been settled through equity conversion as per Cabinet decision and DoT HQ OM No 20-28/2022-PR dated 02.08.2022.

Sh. Dipankar Mahto, CCA Jharkhand discussed the issues and recoverable outstanding dues of Jharkhand Circle. He pointed out that Para (iii) and illustrations given in Annexure II of WPC wing, DoT HQ OM No. P-14010/05/2016 dated 12.08.2016 are mutually contradictory.

For arriving at Floor SUC rate, Para (iii) mentioned that spectrum in 2300 MHz/2500 MHz/band acquired/allocated prior to 2015-16 is to be excluded, whereas in the illustration given in Annexure-II, spectrum held in 2300 MHz/2500MHz band acquired/allocated prior to 2016 Auction needs to be excluded. Hence, this issue may be clarified from DoT HQ. DDG (WPF) replied that O/o CCA, Jharkhand may take up this matter to DoT HQ to issue clarification on it.

Sh. Heikrunjam Prasanject, ACCA, O/o CCA, Assam presented a PPT in connection with issues and aspects of Spectrum Usage Charge and Outstanding Dues that pertains to his circle. Further, Sh. Aditya Das, AO represented NE-I Circle and discussed the issues relating to realization of undisputed outstanding SUC dues.

After that, Sh. Sajal K, Jt CCA, NE-II Circle presented a PPT in connection with realization of undisputed outstanding SUC dues.

Further, Sh Shivendu Gupta, DDG (WPF) discussed about the features of spectrum auction in general and the tentative forthcoming Auctions of spectrum in the near future. He described the process of auction in detail. The process of Auction has been defined as SMRA (Sequential Multiple Round Ascending Auction) where the operators can bid simultaneously in particular Bands/LSAs as per their requirements. He also talked about EMD and the role of eligible points in the auction process. Further the session concluded with a healthy Q&A session with the participants.

Later, Sh. Vivek Drolia, Jt.CCA (O/o Pr. CCA Kolkata), addressed the gathering to share bits about the handbook "AANKLAN". He discussed various best practices adopted by O/o Pr.CCA Kolkata in the assessment of decentralized licensees along with successful case studies.

At last Respected Member (F) & DCC addressed and thanked the gathering for such stimulating discussions in the sessions. He was pleased to be a part of such informative and interactive session that all the doubts and confusions and the resolutions regarding SUC assessment have been discussed in a wholesome manner. He also emphasized to explore the wide aspect of spectrum to play an important role in Indian economy.

It is also pertinent to mention that Respected Member (F), along with other dignitaries visited the CCA office before the beginning of the session of the 2nd day and Member (F) inaugurated the newly renovated Sanchar recreation club in the office premises and dedicated it to all the officers/officials of CCA, Bihar.

At the end of the two day review meet, Sh. Alok Kumar Pandey, Jt.CCA, Bihar delivered the Vote of Thanks to all the venerable participants of this conference and appraise them for their valuable and informative guidance in connection with realization of undisputed outstanding SUC dues and also thanked the chair for entrusting Bihar circle with the responsibility of hosting the Eastern Zone Review Meet.

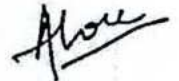

Jt. CCA
O/o CCA Bihar

Copy to:

- (i) PS to Member (F) & DCC.
- (ii) PS to Pr. CCA, Kolkata.
- (iii) DDG (WPF), DoT HQ, New Delhi.
- (iv) DDG (NICF), Ghitorni, New Delhi.
- (v) O/o Pr. CCA/CCAs/Jt. CCA (Kolkata, West Bengal, Bihar, Jharkhand, Assam, NE-I & NE-II)

Government of India
Ministry of Communications
Department of Telecommunications
Wireless Planning and Coordination Wing

6th floor, Sanchar Bhawan,
20, Ashoka Road, New Delhi - 110 001.

No.: L-14041/02/2023-IMT

Date: 03.05.2024

To,
M/s Bharat Sanchar Nigam Limited
Regulation Cell, Corporate Office
3rd Floor, Bharat Sanchar Bhavan
Harish Chandra Mathur Lane
Janpath, New Delhi - 110001

Subject: Assignment of frequencies to BSNL in the 700 MHz and 2100 MHz band - reg.

Reference: (i) BSNL CO-RGLN/28/1/2020-REGLN/E-1834 dated 07-02-2024.

Sir,

As per the decision of the Union Cabinet vide its meetings held on 23-10-2019, and 07-06-2023, the frequency spots are being assigned to you along with the effective date of assignment and the date of expiry as per details mentioned in Annexure -I. Technical parameters are attached at Annexure-II. These spectrum assignments are being done post confirmation of necessary payments by WPF Wing vide their letter dated 10-04-2024 in connection with the demand issued by them vide letter dated 18-03-2024.

2. The frequency assignment, contained in Annexure-I, is subject to the following:
- i. There shall be no change in the frequency assignment or any technical parameters associated therewith, as detailed in Annexure-I, without the prior written approval of Wireless Planning and Coordination (WPC) Wing, Department of Telecommunications, Ministry of Communications.
 - ii. The Government reserves the right to change the frequency spots and technical parameters at any point of time over the duration of its validity period of 20 years, whenever it is required for harmonizing bands and promoting spectrum efficiency.
 - iii. The individual carriers can be combined, provided market determined price was paid for the spectrum, to make use of new technology requiring larger bandwidth. Technology other than GSM/CDMA/WCDMA/LTE/IMT-2020 (5G technology), employed in each band in each LSA, shall be intimated to WPC Wing, wherein prior approval is required.
 - iv. The Base Stations along the borders are to be registered with ITU, through WPC Wing, in order to effect co-ordination in the case of cross-border interference.



- v. The Base Stations near international border shall be so located and operated that the radio signals emanating therefrom, fade out at the international border to an extent to become unusable at the international border, but this condition may be relaxed with the agreement of the administration concerned.
- vi. The new Base Stations or changes to the existing Base Stations to employ the frequencies assigned herein shall not cause harmful interference to a station operating in accordance with the technical parameters authorised by WPC Wing.
- vii. Limits/levels on EMF exposure by Base Stations should be restricted to the limits as prescribed by the Department of Telecommunications from time to time.
- viii. An officer authorised by WPC Wing may inspect the wireless stations to verify that the said stations operate as per technical parameters assigned.
- ix. The SACFA clearance for all the Base Stations shall be obtained from WPC Wing as per the extant procedure.
- x. The wireless equipment to be employed shall be imported, if required, as per the extant procedure.
- xi. The frequency assignment shall be revoked or temporarily suspended, as the case may be, for violation of unauthorised use of frequencies and technical parameters associated therewith, breach of the conditions stipulated in the service license (UL) or non-payment of fees/charges associated with the spectrum.
- xii. The continuation of frequency assignment is subject to fulfilment of all payment terms , adherence to conditions stipulated in the relevant service licenses (UL) and the relevant provisions of the applicable Notice Inviting Applications (NIA-2022).
- xiii. For spectrum in 700 MHz band and 2100 MHz band, which is being assigned with prospective effect, the SUC rate of 0% shall be applicable in the weighted average SUC rate calculation.
- xiv. The above terms and conditions are without prejudice to any other action that may be taken by the Government.

3. The terms and conditions governing frequency spots assigned earlier, if any, would be as per the respective frequency assignment letters. Changeover of frequency spots, if any, shall be done at the earliest not later than 2 weeks' time from the date of issue of this letter.

Encl: Annexure I & II

Copy to:

1. DDG(WPF) for information and necessary action & also for intimating CGCA.
2. DDG(AS) for information and necessary action.
3. Director (WMO) for information and necessary action.

 03/05/2024
 (Jyoti Sharma)
 Engineer (IMT), WPC Wing
 (JYOTI SHARMA)
 अविगन्ता/Engineer
 डी.टी.डी. विभाग, भारत सरकार
 Department of Telecom, Govt. of India
 New Delhi

No. L-14041/02/2023-IMT

Date : 03.05.2024

Frequency carriers assigned to M/s BSNL									
Service Area	No. of blocks	Assigned Carrier Frequencies (in MHz)				BW in MHz	Effective Date	Date of Expiry	Remarks
		700 MHz band (FDD)							
		Uplink		Downlink					
		Start	Stop	Start	Stop				
Gujarat	2	738	748	793	803	10.0	03-05.2024	02.05.2044	
Haryana	2	738	748	793	803	10.0	03-05.2024	02.05.2044	
Himachal Pradesh	2	738	748	793	803	10.0	03-05.2024	02.05.2044	
Odisha	2	738	748	793	803	10.0	03-05.2024	02.05.2044	
Uttar Pradesh(East)	2	738	748	793	803	10.0	03-05.2024	02.05.2044	
Uttar Pradesh(West)	2	738	748	793	803	10.0	03-05.2024	02.05.2044	
Service Area	No. of blocks	Assigned Carrier Frequencies (in MHz)				BW in MHz	Effective Date	Date of Expiry	Remarks
		2100 MHz band (FDD)							
		Uplink		Downlink					
		Start	Stop	Start	Stop				
Andhra Pradesh	1	1959.0	1964.0	2149.0	2154.0	5.0	03-05.2024	02.05.2044	
Gujarat	1	1959.0	1964.0	2149.0	2154.0	5.0	03-05.2024	02.05.2044	
Madhya Pradesh	1	1959.0	1964.0	2149.0	2154.0	5.0	03-05.2024	02.05.2044	
Odisha	1	1959.0	1964.0	2149.0	2154.0	5.0	03-05.2024	02.05.2044	

 (ज्योति शर्मा)
 (JYOTI SHARMA)
 अभियन्ता/Engineer
 दूरसंचार विभाग, भारत सरकार
 Deptt. of Telecom, Govt. of India
 नई दिल्ली/New Delhi

Annexure-II

No. L-14041/02/2023-IMT dated 03-05-2024

Technical Parameters

Technical parameters associated with the frequencies listed in Annexure-I including other common particulars are as given below:

i.	Licensed Service Area	700 MHz: Gujarat, Haryana, Himachal Pradesh, Odisha, Uttar Pradesh (East), Uttar Pradesh (West) 2100 MHz: Andhra Pradesh, Gujarat, Madhya Pradesh, Odisha
ii.	Period of validity	20 years (from the effective date as mentioned in Annexure-I)
iii.	Base Station Power (Max)	2G technology: 20 W 3G/4G technology: As per DoT Office Memorandum No. L-14010/03/2014-NTG dated 19.06.2018. IMT-2020 (5G technology): The permitted maximum RF output power/EIRP of the base station in all the frequency bands and out of band emission limits must be in compliance to the international standards of 3GPP/ITU/TEC etc. and/or international practices adopted by bodies such as CEPT/OFCOM/FCC etc, subject to meeting the EMF limits prescribed by the Department of Telecommunications from time to time.
iv.	Mobile Station Power (Max)	As per TEC/ International standards
v.	Emission (as applicable)	200KG7W, 200KQ7W, 1M40G7W, 3M00G7W, 5M00G7W, 10M00G7W

6/5/24
(ज्योति शर्मा)
(JYOTI SHARMA)
अभियंता/Engineer
दूरसंचार विभाग, भारत सरकार
Dept. of Telecom, Govt. of India
नई दिल्ली/New Delhi

Email

Christeena Joy

Fwd: Recovery of SUC dues with respect to companies under liquidation/CIRP proceedings – Reg.,

From : Christeena Joy <assttcgcarev-dot@gov.in>

Tue, May 14, 2024 04:48 PM

Subject : Fwd: Recovery of SUC dues with respect to companies under liquidation/CIRP proceedings – Reg.,

3 attachments

To : G Venkata Bhavani <aolf.ccaap-dot@gov.in>, CCA, AP <cca-ap@nic.in>, dbacca-ap@nic.in, Lopamudra Mohanty <ccaassam@nic.in>, ccaassam@gmail.com, CCA CHHATISGARH <cca.cg-dot@nic.in>, CCA Gujarat <cca.guj-dot@nic.in>, ccaharyana@gmail.com, cca revenue-rj <cca.revenue-rj@gov.in>, Nirdosh Kumar Yadav <ccaupwest.me-up@nic.in>, MAYANK NEGI <cca-telecom-hp@nic.in>, CCA-HR-REV <aorevcca.amb-dot@gov.in>, CCA JK <ccajk@nic.in>, Dipankar Mahto <cca.jh-dot@nic.in>, Geethanjali H.C <aolf.ccaakar-dot@gov.in>, Ranganath Shyam <ccatrivandrum@nic.in>, pccakolkata@gmail.com, cca mhgoa <cca.mhgoa@gmail.com>, ccamumbai@gmail.com, ccane1 lfsuc <ccane1.lfsuc@gmail.com>, Controller Dept of Telecommunication <ccaodisha.dot@nic.in>, CCA Punjab <cca.pb-dot@nic.in>, CCA Rajasthan <cca-jaip-rj-dot@nic.in>, CCA Tamilnadu <ccatn.tn@nic.in>, Deputy Controller of Communication Accounts <dyccalfuso.ccatn@nic.in>, Sangeet Kumar <cca.upeast@gov.in>, caolfccaupe@gmail.com, Anju Lata <jtccaupwest.me-up@nic.in>, CCA Dehradun <ccaddn-dot@nic.in>, ccadehradun@rediffmail.com, BB Joshi <jtcca.ddn-dot@gov.in>, CCA WB <ccawbc-dot@nic.in>, AO LF <ao-licensefee@ccakolkata.gov.in>

Cc : Ashish Joshi <jtgcgcarev-dot@gov.in>, Pratima Singh <dycgcarev-dot@gov.in>, Tanvika Singh <singh.tanvika@gov.in>, G S S Nikhil Bharadwaj <acao1rev-dot@gov.in>, HITHENDRA CHARY <wpf.wr-dot@gov.in>, Deepa Gurnani <deepa.gurnani05@gov.in>

Respected Sir/Madam,

Kindly refer to the trail mail regarding recovery of SUC dues with respect to companies under liquidation/CIRP proceedings for further necessary action at your end please.

With regards,
Asstt.CGCA(Revenue)
New Delhi

From: donotreply-eoffice@nic.in

To: "singh tanvika" <singh.tanvika@gov.in>, "wpf wr-dot" <wpf.wr-dot@gov.in>, "shivendu gupta" <shivendu.gupta@gov.in>, "ashish joshi" <ashish.joshi@nic.in>, assttcgcarev-dot@gov.in, cgca-dot@gov.in, addcgca-dot@gov.in, dycgcarev-dot@gov.in

Sent: Thursday, May 9, 2024 5:36:36 PM

Subject: Recovery of SUC dues with respect to companies under liquidation/CIRP proceedings – Reg.,

Sir/Madam, Please find enclosed herewith the Lr. No.1020/02/2023-WR. dated 09.05.2024 on the subject. Regards, AO (WR), WPF Wing ? WR Section, DoT Hq

— **I000DOT0003271249_1715251841566.pdf**
89 KB

— **Demand Notes of CIRP TSPs to RP-09.02.2023.pdf**
541 KB

 **SOP(CIRP)-28.06.2023.pdf**
256 KB



File No:1020/02/2023-WR
Government of India
Ministry of Communications
Department of Telecommunications
(Wireless Planning Finance Division – WR Section)

To
The CGCA,
NICF Campus,
Ghitorni, New Delhi – 110047

Dated: xx.05.2024

Sub: Recovery of SUC dues with respect to companies under liquidation/CIRP proceedings – Reg.,

Kindly refer to the Lr. No.LFP-10/29/2022-LFP-II, dated 09.02.2023 (Copy enclosed) wherein guidelines for filing the outstanding dues of LF & SUC with Resolution Professional/Official Liquidator, etc. were circulated.

2. Also refer to Lr. No.12-75/2022-LFP/139807, dated 28.06.2023 (Copy enclosed) wherein the SOP for realizing Government dues and handling Corporate Insolvency Resolution process is circulated.

3. In view of the above, it is once again requested to issue instructions to Assessing Authorities to take periodical action (assessments/filing of claims) in accordance with the guidelines/SOP given in the above orders.

This is issued with the approval of the Competent Authority.

Director (WR)
Ph:011-23036821

Signed by Tanvika Singh
Date: 09-05-2024 16:20:19

Government of India
Department of Telecommunications
Licensing Finance Policy Wing
Sanchar Bhawan, Ashoka Road, New Delhi.

No. LFP-10/29/2022-LFP-II

Date: 09.02.2023

To
CGCA
All Pr. CCAs/CCAs
DDF (LFA)/DDG (WPF)

Subject: Monitoring of Telecom licensees proceeding under liquidation/CIRP proceedings.

When pursuing realization of outstanding dues of License Fees and Spectrum related dues (SUC, Auction related dues, One Time Spectrum Charges etc.) from licensees, it is important to ensure that the dues are duly filed with the Resolution Professional/ Official Liquidator etc. in case of insolvency/ liquidation or related relevant processes. The following guidelines in addition to earlier instructions regarding pursuit of outstanding dues may be followed by all concerned offices for pursuit of outstanding dues in such cases:

- (i) All assessing authorities in DoT HQ /Field offices who are responsible for raising demands of License Fees and Spectrum related dues (SUC, Auction related dues, One Time Spectrum Charges etc.) against a licensee are required to raise all demands in a time bound manner. Regular follow up after issue of demand notices must be done by the assessing authorities who are also required to ensure timely filing of dues as per public announcements under Insolvency and Bankruptcy Code 2016 or other relevant laws/ rules.
- (ii) In case of non-payment of dues, penal action must be taken as per license agreement including but not limited to encashment of BGs, issuing show cause notice etc. without delay.
- (iii) All public announcements of commencement of Corporate insolvency resolution /liquidation process may be checked regularly in the offices concerned with resolution/liquidation. One example where such checks can be made is IBBI website (<https://ibbi.gov.in/en/public-announcement>). Registration for regular intimation may also be available and may be made use of. Regular monitoring by all Pr.CCA/CCA offices is to be done for all licensees coming under their jurisdiction.
- (iv) In case a licensee with outstanding dues is found to be in insolvency/ liquidation or related relevant process, the assessing authority may immediately file the dues with the concerned Resolution Professional/ Official Liquidator etc. within the prescribed timeline. This issues with approval of Competent Authority.

R. Sathish Kumar
Sathish Kumar R
Director (LFP-II)

Copy to:

- 1.PPS to Member (F)
- 2.PPS to Advisor (F)

Government of India
Ministry of Communication
Department of Telecommunications
Licensing Finance Policy Wing
Sanchar Bhawan, 20 Ashoka Road, New Delhi-110001

No.12-75/2022-LFP/139807

Date: 28.06.2023

Subject: Standard Operating Procedure (SOP) regarding realizing Government dues and handling Corporate Insolvency Resolution Process-reg

The undersigned is directed to forward herewith the Standard Operating Procedure (SOP) regarding realizing Government dues and handling Corporate Insolvency Resolution Process for necessary compliance

This issues with the approval of Secretary(T).

Sharma
28/6/23
ADG(LFP)

Encl: As Above

To:

1. CGCA
2. DGT
3. Wireless Advisor
4. DG(NICF)
5. All Pr. CCAs/CCAs
6. All DDGs of Licensing Wings/DDG(LFA)/DDG(WPF)/DDG(Satellite)

Copy to:

1. PSO to Secretary(T)
2. PSO to Member(F)
3. PSO to Member(T)
4. Sr. PPS to Advisor(F)

**Government of India
Ministry of Communications
Department of Telecommunication
(Licensing Finance Policy Wing)
Sanchar Bhavan, Ashoka Road, New Delhi 110001**

Subject: SOP regarding realizing government dues and handling Corporate Insolvency Resolution Process (CIRP) cases-reg.

It has been observed that there is an inordinate delay in filing claims by certain wings/field offices of DoT leading to these claims not being admitted and extinguished once the resolution plan is passed. To avoid such scenarios in future an SOP is formulated to ensure timebound filing of claims and follow up necessary actions as per the rules/regulations of Insolvency Bankruptcy Code (IBC) 2016.

Standard Operation Procedure (SOP) for Insolvency cases

1. For Licensees whose assessment is done centrally

Step 1: Intimation about CIRP initiation

- LFP wing will monitor all Licensees and will disseminate information about insolvency to the office of CGCA, DG(T) and other wings of DoT. Office of CGCA and DG(T) will communicate with Pr. CCAs/CCAs and LSAs respectively.
- LFP wing will obtain Company Specific Subscription on IBBI website via Corporate Identification Number (CIN) of the Company to get regular updates about initiation of insolvency and its status thereafter.

Step 2: Consolidation of Dues and filing of Claims to Insolvency Resolution Professional (IRP)

- Office of CGCA and DG(T) will consolidate dues along with proof of claims pertaining to CCAs, and LSAs respectively and file them in the required format to the Insolvency Resolution Professional (IRP)/Official Liquidator (OL) within the required time frame without fail. Each office which raises the demand against the licensee is responsible for defending the same before IRP/OL or

any judicial forum as the case may be. A final copy of the filed dues must be shared with LFP wing.

- All other wings of DoT, whoever raises any demand, will consolidate dues along with proof of claims for defending the same and submit to LFP wing in a time bound manner for onwards filing to IRP. No request for onward submission of the claims will be accepted after the cutoff date is passed.

Step 3: Representing DoT in NCLT/NCLAT/Supreme Court

- LFP will be nodal wing to correspond with the Resolution Professional (RP) after filing of dues regarding finalization of the Resolution Plan and defending the interest of the Department before the committee of creditor (COC), Stakeholder Consultation Committee and NCLT, NCLAT and Supreme Court as the case may be.
- While defending the case, LFP wing may assign some responsibilities to any wing/field unit of the Department as the need arises.

In case the Resolution Plan fails:

In the above scenario, the concerned company goes for liquidation and the whole process of submitting claims starts afresh. Dues along with interest may be recalculated upto the Liquidation Commencement Date as mentioned in the Public Announcement.

- If such a case arises, Step 2 and Step 3 will again be repeated in the same manner as defined above.

2. For Licensees whose assessment is done at PrCCA/CCA level

Step 1: Intimation about CIRP initiation

- Office of Pr. CCAs/CCAs will be responsible for monitoring such licensees and disseminate information about insolvency to the office of CGCA, LFP, DG(T) and DS wing who may further disseminate the information to relevant stakeholders.
- PrCCA/CCA will obtain Company Specific Subscription on IBBI website via Corporate Identification Number (CIN) of the

Company to get regular updates about initiation of insolvency and its status thereafter.

Step 2: Consolidation of Dues and filing of Claims to Insolvency Resolution Professional (IRP)

- Concerned Pr. CCA/CCA will take necessary actions with respect to the consolidation of dues and filing of claims.
- Other wing/office will provide consolidated dues, if there are any, to the office of concerned Pr. CCA/CCA before the cutoff dates.
- Each office which raises any type of demand against the licensee must be ready to defend the same before IRP/OL/any judicial forum as the case may be
- No request for onward submission of claims from any wing/field office will be entertained after the cutoff date is passed.

Step 3: Representing DoT in NCLT/NCLAT/Supreme Court

- Concerned Pr. CCA/CCA will represent the Department in Committee of Creditors and NCLT and take all necessary steps for defending the interest of the Department. The concerned Pr CCA/CCA office should keep informed CGCA and LFP wing about all proceedings.
- LFP wing will handle the case in NCLAT and Supreme Court if the need arises.

In case the Resolution Plan fails:

In the above scenario, the concerned company goes for liquidation and the whole process of submitting claims is once again started. Dues along with interest may be recalculated up to the Liquidation Commencement Date as mentioned in the Public Announcement.

- If such a case arises, Step 2 and Step 3 will again be repeated in the same manner as defined above.

3. For Licensees issued by WPC

WPC wing will monitor all the operators/companies whom they issue license or allocate administrative spectrum. Individual licensing group in WPC wing who raises the demand will be responsible for filing and defending the claims before IRP/OL/any judicial forum and share a copy of final dues submitted to IRP/OL with LFP wing. And follow the case in NCLT, NCLAT or Supreme Court whenever required.

In case the Resolution Plan gets rejected:

In the above scenario, the concerned company goes for liquidation and the whole process of submitting claims is once again started. Dues along with interest may be recalculated upto the Liquidation Commencement Date as mentioned in the Public Announcement.

- If such a case arises, the above given process will again be repeated in the same manner as defined above.

4. It is to be noted that during the period of Corporate Insolvency Resolution Process, the concerned office may raise a demand against the licensee against the current dues arising out of use or continuation of the license during the moratorium period.

5. It is also to be stated that all wings of DoT/Field offices who are responsible for raising demands against a licensee, are solely responsible for realization of the same. The responsibility does not end with submission of claims. Each concerned office must be vigilant of CIRP proceedings until the logical resolution of their claims.

6. In case of licenses whose assessment is done by PrCCA/CCAs or WPC, a quarterly report should be submitted to LFP wing regarding the insolvency/liquidation status of all their licensees/operators and the steps taken therein for realization of their claims.

7. Licensing Wings of DoT will provide a certified list of all the companies with the type of license and the CIN of the Company to LFP wing within two weeks of this SOP coming into force.

8. All Legal cases other than the insolvency process will be dealt by those offices who are currently responsible for the same.

9. National Institute of Communication Finance (NICF) shall organize a periodic training program related to process of filing claims and other issues related to Insolvency and Bankruptcy Code, 2016 at regular interval.

This issues with the approval of Secretary(T).

R. Sathishkumar
Director (LFP-I)

Allotment of Residual Spectrum in 1800 Mhz Band left over due to uneven block size in spectrum auction held in Nov 2012 - Reg.,

From : donotreply-eoffice@nic.in

Wed, May 15, 2024 03:46 PM

Subject : Allotment of Residual Spectrum in 1800 Mhz Band left over due to uneven block size in spectrum auction held in Nov 2012 - Reg.,

3 attachments

To : singh tanvika <singh.tanvika@gov.in>, wpf wr-dot <wpf.wr-dot@gov.in>, sanjeev arora <sanjeev.arora@vodafoneidea.com>, shivendu gupta <shivendu.gupta@gov.in>, ashish joshi <ashish.joshi@nic.in>, assttcgcarev-dot@gov.in, cgca-dot@gov.in, addcgca-dot@gov.in, nitin singh <nitin.singh@vodafoneidea.com>, gagandeep bajaj <gagandeep.bajaj@VodafoneIdea.com>, dycgcarev-dot@gov.in**Reply To :** do-not-reply@eoffice.gov.in

Sir/Madam, Please find enclosed herewith the Lr. No.1034/02/2022-WR, dated 15.05.2024 on the subject. Regards, AO (WR), WPF Wing ? WR Section, DoT Hq

 **I000DOT0003271261_1715767616839.pdf**
136 KB

 **Spectrum Residual offered in 1800 MHz band-30.09.2016.pdf**
1 MB

 **Spectrum Residual allotment in 1800 MHz band to Vodafone-05.12.2016.pdf,**
713 KB



सत्यमेव जयते

File No:1034/02/2022-WR
Government of India
Ministry of Communications
Department of Telecommunications
(Wireless Planning Finance Division – WR Section)

To
M/s.Vodafone Idea Limited,
7th floor, Konnectus Tower 3,
Bhavbhuti Marg,
Opp New Delhi Railway Station,
New Delhi-110002.

Dated: 15.05.2024

Sub: Allotment of Residual Spectrum in 1800 Mhz Band left over due to uneven block size in spectrum auction held in Nov 2012 - Reg.,

This is with reference to the Lr. Ni.VIL/RCA/2024/May/0601-002, dated 06.05.2024.

2. It is requested to refer to the "Guidelines for allotment of residual spectrum in 1800 MHz band as a result of spectrum auction held in November-2012" issued vide DoT Lr. No.L-14010/01/2016-NTG, dated 30.09.2016 (copy enclosed) under which M/s Vodafone had applied for allotment of residual spectrum. The relevant para of the guidelines are given hereunder:

"Para-(i) The residual spectrum will be governed by conditions laid down in the Notice Inviting Application dated 28.09.2012 issued for the auction of spectrum held in November, 2012. The residual spectrum shall be treated akin to spectrum acquired through the spectrum auction held in November, 2012."

3. Further, DoT had allotted the residual spectrum in 1800 MHz to M/s.Vodafone vide Lr. No.L-14004/02/2016-NTG, dated 05.12.2016. The relevant para reiterating the conditions are detailed hereunder:

"Para-2: The use of residual spectrum will be governed by all the relevant conditions laid down in the Notice Inviting Application dated 28.09.2012 and the relevant service license i.e. CMTS/UAS/UL and their amendments"

4. In view of the above, it is evident that the residual spectrum allotted to M/s.Vodafone in 1800 Mhz, shall be governed by the conditions laid down in the NIA-2012 and SUC rate shall be levied as per NIA-2012. Further, SUC weighted average rate will be calculated in accordance with the SUC order dated 12.08.2016.

5. Accordingly, the SUC rate applied by the Assessing Authorities for residual spectrum is in line with the DoT guidelines.

This is issued with the approval of the Competent Authority.

Director (WR)/L.O
Ph:011-23036821

Copy to: **The CGCA, NICF Campus, Ghitorni, New Delhi – 110047** signed by request to circulate the same to Assessing Authorities.

Dhammapal Anil Khandagale
Date: 15-05-2024 15:36:41

Government of India
Ministry of Communications & Information Technology
Department of Telecommunication
(WPC Wing)

No. L-14004/02/2016-NTG

Dated: 05.12.2016

To,
M/s Vodafone Mobile Service Limited
C-48, Okhla Industrial Area, Phase II,
New Delhi - 110020

Subject: Allotment of Residual spectrum in 1800 MHz band left over due uneven block size in the spectrum auction held in November 2012.

Reference:

1. M/s Vodafone Mobile Services Limited Letter Nos. VMSL/DoT/10-16/01 dated 03.10.2016.
2. DOT Demand Notes No. 1000/12/2016 -WF (Auction) dated 27.10.2016
3. DOT payment confirmation letter No. 1000/12/2016/partial spectrum payment - WF/ Auction dated 03.11.2016.

Sir

I am directed to refer to your letter dated 03.11.2016 for allotment of residual spectrum in 1800 MHz band in 13 service areas, subsequent receipt of confirmation of payment on 03.11.2016, convey the allotment of residual spectrum as per detail attached at Annexure.

2. The use of residual spectrum will be governed by all the relevant conditions laid down in the Notice Inviting Application dated 28.09.2012 and the relevant service license i.e. CMTS/ UAS/ UL and their amendments.
3. Spectrum usage Charges (SUC) will be required to be paid for the above residual spectrum in accordance with the SUC Order dated 12th August, 2016.
4. The effective date for calculation of SUC for the above liberalised spectrum will be from 11.11.2016.
5. Other terms & conditions mentioned in the original earmarking letter/ allocation letters/ its amendments for the spectrum blocks won in November 2012 spectrum auction will remain unchanged.

OK

Yours faithfully,

PSM
(PSM Tripathi)

Deputy Wireless Advisor

Copy for information:

1. Sr. DDG (AS-I), DOT, Sanchar Bhawan, New Delhi - 01
2. Director (WMO), DOT, Pushpa Bhawan, New Delhi-110062
3. DDG (WPF), DOT, Sanchar Bhawan, New Delhi - 01

*Recd
S/O
15/12/2016
-kone
-518*

(Official stamp)
D. No. 14004/02/2016-NTG
Date: 05.12.2016

Anexure-I

Vodafone Mobile Services Limited

Name of Service Area	Uplink		Downlink		Total Spectrum	Remarks	Date of Expiry
	From	To	From	To			
Assam	1742.00	1742.10	1837.00	1837.10	0.10	Entire Service Area 19.12.12	18.12.2032
Bihar	1736.40	1736.50	1831.40	1831.50	0.10	Entire Service Area 19.12.12	18.12.2032
Haryana	1740.80	1740.90	1835.80	1835.90	0.10	Entire Service Area	18.12.2032
Himachal Pradesh	1737.55	1737.70	1832.55	1832.70	0.15	Entire Service Area	18.12.2032
Jammu & Kashmir	1742.80	1742.90	1837.80	1837.90	0.10	Entire Service Area	18.12.2032
Kerala	1739.95	1740.10	1834.95	1835.10	0.15	Entire Service Area	18.12.2032
Madhya Pradesh	1741.60	1741.70	1836.60	1836.70	0.10	Entire Service Area	18.12.2032
Maharashtra	1730.55	1730.70	1825.55	1825.70	0.15	Entire Service Area	18.12.2032
North East	1752.80	1752.90	1847.80	1847.90	0.10	Entire Service Area	18.12.2032
Punjab	1740.15	1740.30	1835.15	1835.30	0.15	Entire Service Area	18.12.2032
Utter Pradesh (East)	1728.35	1728.50	1823.35	1823.50	0.15	Entire Service Area	18.12.2032
Utter Pradesh (West)	1731.50	1731.60	1826.50	1826.60	0.10	Entire Service Area	18.12.2032
West Bengal	1742.60	1742.70	1837.60	1837.70	0.10	Entire Service Area	18.12.2032

19.12.12
19.12.12

Government of India
Ministry of Communications
Department of Telecommunication
(WPC Wing)

No. L-14010/01/2016-NTG

Dated 30.09.2016

OFFICE MEMORANDUM

Subject: Allotment of residual spectrum in 1800 MHz band as a result of spectrum auction held in November 2012.

Telecom Service Providers, who won spectrum with a quantum of 1.25 MHz, 2.5 MHz and 6.25 MHz in 1800 MHz band in the spectrum auction held in November 2012 in a service area, can apply for allotment of residual spectrum.

1.1 The TSPs and the quantum of spectrum won in 1800 MHz band in the spectrum held in November 2012, are given in the table below.

Service Area	Name of TSP	Quantum of spectrum won	Quantum of residual spectrum offered
Assam	Bharti	1.25 MHz	0.15 MHz
	Vodafone	2.50 MHz	0.10 MHz
Bihar	Idea	1.25 MHz	0.15 MHz
	Vodafone	2.50 MHz	0.10 MHz
Haryana	Vodafone	2.50 MHz	0.10 MHz
Himachal Pradesh	Vodafone	1.25 MHz	0.15 MHz
Jammu & Kashmir	Vodafone	2.50 MHz	0.10 MHz
Kerala	Vodafone	1.25 MHz	0.15 MHz
Madhya Pradesh	Vodafone	2.50 MHz	0.10 MHz
Maharashtra	Vodafone	1.25 MHz	0.15 MHz
North East	Vodafone	2.50 MHz	0.10 MHz
Orissa	Vodafone	2.50 MHz	0.10 MHz
Punjab	Vodafone	1.25 MHz	0.15 MHz
UP(East)	Vodafone	1.25 MHz	0.15 MHz
UP(West)	Vodafone	2.50 MHz	0.10 MHz
West Bengal	Vodafone	2.50 MHz	0.10 MHz
	Idea	6.25 MHz	0.15 MHz

1.2 The procedure for allotment of residual spectrum in 1800 MHz band as a result of spectrum auction held in November 2012 is enclosed.

2. Interested TSPs are requested to apply for assignment of residual spectrum in all their LSAs at one time.

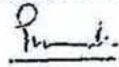
(P S M Tripathi)
Deputy Wireless Adviser
Tel: 23355439

Copy to:

1. Secretary TRAI, New Delhi
2. DDG(WPF), DDG(LFA) DOT New Delhi
3. Sr. DDG(LFP)/Sr. DDG(AS), DOT New Delhi

Guidelines for allotment of residual spectrum in 1800 MHz band as a result of spectrum auction held in November 2012

The Competent Authority, hereby, lays down the following terms and condition for allotment of residual spectrum in 1800 MHz band against the spectrum won in the auction held in November 2012, in which block size was 1.25 MHz.

- (a) This guidelines will be applicable for TSPs, who won spectrum in the spectrum auction held in November 2012 in the block size of 1.25 MHz/ 2.50 MHz/3.75 MHz.
- (b) The residual spectrum ranging from 0.05 MHz to 0.15 MHz will be assigned prorated for balance validity period of November 2012 allocation at the latest auction determined price. At present market price shall be the price to be discovered in the spectrum auction commencing from October 01, 2016.
- (c) The quantum of residual spectrum to be allotted is as under:

Quantum of spectrum won in 1800 MHz band in November 2012 Auction	Quantum of residual spectrum to be allotted
1.25 MHz	0.15 MHz
2.50 MHz	0.10 MHz
3.75 MHz	0.05 MHz

- (d) In case more than one set of auction determined prices are available, the latest auction determined prices available at the time when the TSP wants to acquire residual spectrum, would be applied.
- (e) If the auction determined price is more than one year old then the prevailing market rates would be determined by indexing the last auction price at the rate of SBI PLR.
- (f) The date of calculation of the total amount due for residual spectrum will be the fifteenth (15) days from the date of issue of Demand note and the same will be taken as the Effective Date of assignment of residual spectrum.
- (g) Payment will be required to be made within fifteen days from the date of issue of Demand Note, failing which the Demand note will be deemed to have expired and the TSP will have to make a fresh request for assignment of residual spectrum.

[Handwritten Signature]
Director, Spectrum
Department of Telecommunications
Government of India

- (h) The residual spectrum can be combined with the spectrum chunk acquired by the TSPs in the spectrum auction held in November 2012.
- (i) The residual spectrum will be governed by conditions laid down in the Notice Inviting Application dated 28.09.2012 issued for the auction of spectrum held in November 2012. The residual spectrum shall be treated akin to spectrum acquired through the spectrum auction held in November 2012.

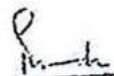

(P S M Tripathi)
Deputy Wireless Adviser
Tel: 23355439

100, 100, 100, 100
100, 100, 100, 100
100, 100, 100, 100
100, 100, 100, 100
100, 100, 100, 100